

ALPINE CANADA



ACA FITNESS COMBINE

ALPINE CANADA ALPIN
FALL 2022





FALL 2022
ALPINE CANADA ALPIN
FITNESS COMBINE

TABLE OF CONTENTS

Purpose	4
Administration	4
ACA fitness combine exercises	6
Field testing components	6
Gym testing components	7
Testing order	8
Pre-test preparations	8
Warm up	9
Composite Score	11
ACA Fitness Combine Field Exercises & Benchmarks	13
AIS 20m shuttle-run (beep test)	13
Hexagonal obstacle	15
Modified Hexagonal Agility	17
Standing long jump	19
Double leg Penta jump	21
Single leg Penta jump	23
Max push-ups (Tempo Imposed)	25
Pull ups	26
Flexed arm bar hang	28
Sit ups	29
Brutal bench	30
45/60/90 second box jump	32
ACA Fitness Combine Gym Tests & Benchmarks	35
Squat technique	35
Submaximal squat	37
Deadlift technique	39
Submaximal deadlift	41
References	43
Appendix A – Scoring Tables	45
AIS 20m shuttle-run (beep test)	45
Hexagonal Obstacle & Modified Hexagonal Agility	46
Standing Long Jump	50
Double leg Penta jump	51
Single leg Penta jump	52
Max push-ups (Tempo Imposed)	53
Pull ups	54
Sit ups	55
Brutal bench	56
45/60/90 second box jump	57
Submaximal squat	61
Submaximal deadlift	62
Appendix B – Field Test Score recording sheets	63
AIS 20m shuttle-run (beep test)	63
Hexagonal Obstacle & Modified Hexagonal Agility	64
Standing Long Jump	65
Double leg Penta jump	66
Single leg Penta jump	67
Max push-ups (Tempo Imposed)	68
Pull ups	69



Flexed arm bar hang	70
Sit ups	71
Brutal bench	72
45/60/90 second box jump	73
Appendix C – 20m Shuttle-Run layout options	76
Appendix D – Gym Testing Technical Evaluation Forms	77
Squat Technique Evaluation Form	77
Deadlift Technique Evaluation Form	78
Appendix E – ACA Fitness Combine Individual Scoring Forms	79
U10 Athletes	79
U12 Athletes	80
U14 Athletes	81
U16 Athletes	82
U18+ Athletes	83



PURPOSE

The development of general physical fitness is a necessary component for elite ski racers. Physical literacy, the establishment of efficient fundamental movement patterns in coordination in various situations, and the development of general strength, power, and endurance are critical neuromuscular and physiological capacities required of elite-level ski racers.

An athlete's fitness level will either support or inhibit technical skill development by greatly influencing their ability to tolerate the training volumes required across different stages of development.

Analysis and research have shown that the following physical fitness factors are characteristic of the top ski racers:

1. Good aerobic work capacity (high maximal oxygen uptake/VO₂Max)
2. Great muscular strength in terms of dynamic muscle function
3. Significantly prolonged muscular endurance, in terms of dynamic muscle function in given submaximal work
4. Well-developed muscular coordination

The assessment and quantification of these qualities can help identify potential performance deficits and track long-term performance trends. This document provides an overview of Alpine Canada Alpin (ACA) nationwide physical fitness combine protocol. As ACA collects data and builds normative trends for each gender and phase of development, the ACA Fitness Combine will identify target areas for later development to promote the development of successful elite-level ski racers.

There may be certain situations where teams have access to more sophisticated testing methods. This nationwide physical fitness combine program does not prevent the inclusion of additional testing. Instead, it provides guidelines for benchmarking ski-specific fitness abilities that are important for all ski racers in the development pathway. A coach can use the data gathered from each test to determine an athlete's starting point more accurately with their developmental and physical fitness stages and track subsequent progress through re-evaluation. This will promote the construction of an appropriate training program that serves the athlete's needs in the context of their sport, ski racing, and is suitable for the athlete's capabilities.

In summary, the ACA Fitness Combine protocol represents a critical step forward in Canadian alpine ski racing. Standardized physical fitness testing implemented across various stages of development contribute to this cohesive pathway. A development pathway is not a series of independent stops as a skier ascends the ranks to international competition. Instead, it should be one continuous effort on behalf of all stakeholders to provide a fun, cohesive and exhilarating experience for all athletes.

ADMINISTRATION

The effective administration of each test is detailed within this manual. A coach or administrator should consider the following when administering each test, which are provided within this ACA Fitness Combine Protocol:

- Rationale
- Equipment needed (calibration and maintenance required for accuracy)
- Methodology and protocols including contraindications
- Preparation (warm-up)
- Scoring and recording
- Recovery time
- Inclusion of the Movement Competencies screen to identify basic mobility, stability, and asymmetry concerns

Through the consistent administration of the tests and considerations of their components, both validity and reliability of the ACA Fitness Combine will be improved. Appropriate test administration and recording are crucial for reporting



accurate data that will benefit both athletes and coaches. When implemented correctly, the ACA Fitness Combine will be an important assessment of the overall process of athlete development.

By identifying an athlete's existing abilities in the following exercises, the appropriate foundations can be built upon. This will promote greater effectiveness of the sport-specific and high-performance strategies to come, which will subsequently support and enhance performance throughout an athlete's career. All the exercises contained within the ACA Fitness Combine include benchmarking tables.

The use of proper equipment, protocols, planning, and set-up are critical components to running a successful ACA Fitness Combine including:

- Pre-determining the athlete group(s) size
- Organization of space to enhance flow and ensure adequate space to conduct the assessment
- The number of support staff/coaches involved
- Time to train support staff/coaches
- Maintenance of a rotational schedule to ensure groups can easily move from station when testing large groups of athletes for effective management
- Scoring and reporting athlete scores to the athletes, coaches and parents are all critical considerations

Reliable data and consistent testing procedures are dependent on a few critical factors:

- All ACA Fitness Combine staff, coaches, and volunteers must respect and understand that all data, results, belong to the athlete and maintain the confidentiality of an athlete's ACA Fitness Combine results.
- Follow the same order and protocols for each testing
- Perform the tests in a similar environment (gymnasium is recommended)
- Provide adequate rest/recovery for each test
- It is highly recommended that the athletes complete a health screening or medical clearance to participate. The PAR-Q (Physical Activity Readiness – Questionnaire) can be completed prior to testing as part of the athlete intake.

The ideal logistical preparation will allow for a 1:1 ratio of scorer to athlete being scored. This becomes challenging. In general, if two athletes are participating in a test at one time, there should be two scorers, or at a minimum one scorer and two counters if two athletes are testing at a station.



ACA FITNESS COMBINE EXERCISES

The ACA Fitness Combine exercise components are defined by stage of development. The general purpose of the ACA Fitness Combine is to evaluate an individual's general physical fitness while assessing a wide range of physical characteristics required for technical skill development and influence the athlete's ability to tolerate the training volumes required across different stages of development to become an elite ski racer. The ACA Fitness Combine consists of ten (10) field testing exercises and two (2) gym-based exercises.

Field Testing Components

The shaded regions show the ACA Fitness Combine progression by age group.

Exercise	Fitness Component	U10	U12	U14	U16	U18*	U21	U23	Senior	PTSO Teams	ACA Teams
20m Beep (AIS)	Aerobic capacity										
Hexagonal Obstacle/Modified Hexagon	Coordination & speed										
Standing Long Jump	Lower body speed-strength & coordination										
Double Leg Penta* Jump	Lower body speed-strength & coordination										
Single Leg Penta* Jump	Lower body speed-strength & coordination										
Max Push Ups Tempo Imposed	Upper body strength endurance & stabilization										
Pull Ups/Bar Hang*	Upper body strength endurance										
Sit Ups*	Abdominal strength										
Brutal Bench	Abdominal Strength										
45sec Box Jump	Anaerobic Capacity										
60sec Box Jump*	Anaerobic Capacity										
90sec Box Jump*	Anaerobic Capacity										

*Transitioning to the full testing battery occurs when athletes turn 16 years old. However, this transition must be considered for each individual athlete based on their maturity and training history. Safety and quality in the execution of the tests should always be a top priority and athletes should only transition when they are physically ready.



Gym Testing Components

The shaded regions show the ACA Fitness Combine progression by age group.

Exercise	U10	U12	U14	U16	U18	U21	U23	Senior	PTSO Team	ACA Team
Squat Technique										
Submaximal Squat 0.50x BW (W) 0.75x BW (M)										
Submaximal Squat 0.75x BW (W) 1.00x BW (M)										
Submaximal Squat 1.00x BW (W) 1.25x BW (M)										
Submaximal Squat 1.25x BW (W) 1.50x BW (M)										
Deadlift Technique										
Submaximal Deadlift 1.00x BW (W) 1.25x BW (M)										
Submaximal Deadlift 1.25x BW (W) 1.50x BW (M)										
Submaximal Deadlift 1.50x BW (W) 1.75x BW (M)										
Submaximal Deadlift 1.75x BW (W) 2.00x BW (M)										

*Transitioning to the gym testing occurs when athletes turn 17 years old. However, this transition must be considered for each individual athlete based on their maturity and training history. Safety and quality in the execution of the tests should always be a top priority and athletes should only transition when they are physically ready.

**The strength testing portion of the gym testing can be completed on a separate day from the field testing. It can also be omitted if there is a lack of facility or qualified evaluators. At the minimum, a technical evaluation of lifting technique should be incorporated.



TESTING ORDER

To be able to compare an athletes results from ACA Fitness Combine to ACA Fitness Combine, it is very important to follow the testing order. The ACA Fitness Combine protocol is designed to be implemented from start to finish in its entirety. National Team testing, as well as any nationally “validated” testing, will be run in this way to ensure consistency and standardization. This will help promote the collection of valid data, systematic analyses of the data, and accurate tracking of performance improvement.

U10	U12	U14	U16	U18+
Warm Up – 30 mins	Warm Up – 30 mins	Warm Up – 30 mins	Warm Up – 30 mins	Warm Up – 30 mins
20m Beep Test (AIS)	20m Beep Test (AIS)	20m Beep Test (AIS)	20m Beep Test (AIS)	20m Beep Test (AIS)
Modified Hexagon	Modified Hexagon	Hexagon	Hexagon	Hexagon
Standing Long Jump	Standing Long Jump	Standing Long Jump	Standing Long Jump	Standing Long Jump
15 Minute Break	15 Minute Break	Penta Jump (Double leg)	Penta Jump (Double leg)	Penta Jump (Double leg)
Max Push Ups Tempo Imposed	Max Push Ups Tempo Imposed	Penta Jump (Single leg)	Penta Jump (Single leg)	Penta Jump (Single leg)
Pull Ups/Bar Hang*	Pull Ups/Bar Hang*	15 Minute Break	15 Minute Break	15 Minute Break
Sit Ups	Sit Ups	Squat Technique**	Squat Technique**	Submaximal Squat
Squat Technique**	Squat Technique**	Deadlift Technique**	Deadlift Technique**	Submaximal Deadlift
15 Minute Break	Deadlift Technique**	Max Push Ups Tempo Imposed	Max push-ups (Tempo Imposed)	15 Minute Break
45 second Box Jump	15 Minute Break	Pull Ups/Bar Hang*	Pull Ups	Max push-ups (Tempo Imposed)
	60 second Box Jump	Sit Ups	Brutal Bench	Pull Ups
		15 Minute Break	15 Minute Break	Brutal Bench
		60 second Box Jump	90 second Box Jump	15 Minute Break
				90 second Box Jump
<ul style="list-style-type: none"> • The bar hang exercise is an alternative for U14, and younger athletes and it is not included as part of the scoring system. • Squat and Deadlift technique exercises are not included as part of the scoring system. • The gym tests may be excluded if a proper gym facility and trained S & C staff are unavailable. 				

PRE-TEST PREPARATIONS

Familiarize testing evaluators and coaches with the protocols for each exercise contained within the ACA Fitness Combine Protocol.

Coaches introduce athletes to and practice the individual exercises ahead of the ACA Fitness Combine evaluation event during scheduled dryland sessions ahead of the ACA Fitness Combine event.

Locate a suitable testing venue.

- Non-slip surface
- Preferably indoors to minimize environmental factors.

Prepare athletes and parents ahead of the ACA Fitness Combine evaluation event about factors that influence performance.

- Ensure athletes are rested and have fully recovered from heavy training



- Be well hydrated and bring water to testing
- Fueled (nutrition) and have had only a light meal one or two hours before participating and have snacks available during testing
- Wear comfortable clothing and non-slip footwear
- Ensure athletes are free from any injury or illness; if in doubt, consult your doctor

Ensure all athletes participating in the ACA Physical Fitness Combine understand the protocol, physical requirements, and are medically cleared to participate. It is recommended that all athletes participating in the ACA Physical Fitness Combine sign a waiver prior to participating.

WARM UP

All athletes participating in the ACA Fitness Skills Combine must complete a warm-up prior to undertaking any of the fitness evaluations.

Purpose

Begin with a general warm-up, gradually ramping into more dynamic movements and higher speeds. Athletes should be prepared to sprint, jump, cut, and perform upper body activity by the end of the warm-up.

General Warm-up

5 minutes of low intensity active movement; walking (low-impact exercise)

Preparation Core Circuit

1. Tabletop position Cat to Camel
2. Prone Scorpions 4 reps each side
3. 30s Plank on forearms – isometric Hold
4. 30s Lateral plank – isometric Hold – each side
5. Plank to downward dog to plank position to push up - 8 reps
6. Glute Bridge 15 reps

Dynamic Flexibility/Mobility

1. Deep forward lunge stretch – 4 each leg
2. Hand walk/inch worm – 4 reps
3. Heel to glute with arm reach 10 reps each side
4. Lateral lunge stretch – 4 each leg
5. Crossover lunge stretch – 4 each leg
6. Standing leg cradle with toe raise – 4 each leg
7. Bear crawl forward and backward – 10m each
8. Body weight deep squat – hands behind head – 8 reps
9. Plank with shoulder tap – 8 reps each arm

Movement Preparation

1. Forward lunge with core rotation – 10 m
2. Backward lunge with core rotation – 10m
3. Hurdle walk forwards – 10m
4. Hurdle walk backwards – 10m
5. High knees march to run – forward – 10m
6. High knees march to run – backward – 10m
7. Side shuffle with arm swing – high – 10m each way
8. Carioca – 10m each way



9. Forward skip with arm swing – 10m
 10. Backward skip with arm swing – 10m
 11. Forward power skip for height – 20m
-



COMPOSITE SCORE

For each of the ACA Fitness Combine events, a scoring table has been developed, which are used to calculate the total ACA Fitness Combine score for each athlete. Each “absolute” test score renders a specific point total. Because not all fitness components are equally important to ski racing, ACA has created a weighting system that maximizes points scored in fitness tests that are more important to ski racing performance and training requirements.

The points total earned by the athletes in each test will then be combined to create an overall ACA Fitness Combine score. The points sum from all the exercises below count towards the total score. The athlete must complete 8 of the evaluations for the score to count and for the records to be registered in the ACA Fitness Combine results database.

COMBINE SCORE CALCULATIONS BY AGE GROUP

U10/U12 Combine Score Calculation

Exercise	Possible Points	% Of Total Score	Performance Score to obtain Max Points
20m Beep (AIS)	325	25%	15,13 (level, shuttle)
Modified Hexagon Agility	145	11%	9.37 sec
Standing Long Jump	125	10%	3.15m/3.75m
Max Push Ups (Tempo Imposed)	125	10%	70 reps
Pull Ups/Bar Hang*	105	8%	25 reps
Sit Ups	125	10%	70 reps
45 sec Box Jump	325	25%	65 reps
Total Possible Points	1275		

*Bar Hang is not included in the combine score calculation

U14 Combine Score Calculation

Exercise	Possible Points	% Of Total Score	Female Performance Score to obtain Max Points	Male Performance Score to obtain Max Points
20m Beep (AIS)	325	23%	15,13 (level, shuttle)	15,13 (level, shuttle)
Hexagon Obstacle	145	10%	20.60 sec	20.60 sec
Standing Long Jump	125	9%	3.15m	3.75m
Double Leg Penta Jump	125	9%	13.5m	13.5m
Max Push Ups (Tempo Imposed)	125	9%	70 reps	70 reps
Pull Ups/Bar Hang*	105	8%	25 reps	25 reps
Sit Ups	125	9%	70 reps	70 reps
60 sec Box Jump	325	23%	98 reps	100 reps
Total Possible Points	1400			

*Bar Hang is not included in the combine score calculation



U16 Combine Score Calculation

Exercise	Possible Points	% Of Total Score	Female Performance Score to obtain Max Points	Male Performance Score to obtain Max Points
20m Beep (AIS)	325	21%	15,13 (level, shuttle)	15,13 (level, shuttle)
Hexagon Obstacle	145	9%	18.10 sec	9.37 sec
Standing Long Jump	125	8%	3.15m/3.75m	3.15m/3.75m
Double Leg Penta Jump	125	8%	13.5m	16.1m
Single Leg Penta Jump	125	8%	12.2m	13.9m
Max Push Ups (Tempo Imposed)	125	8%	70 reps	70 reps
Pull Ups	105	7%	25 reps	25 reps
Brutal Bench	161	10%	40 reps	40 reps
90 sec Box Jump	325	21%	110 reps	120 reps
Total Possible Points	1561			

U18+ Combine Score Calculation

Exercise	Possible Points	% Of Total Score	Female Performance Score to obtain Max Points	Male Performance Score to obtain Max Points
20m Beep (AIS)	325	16%	15,13 (level, shuttle)	15,13 (level, shuttle)
Hexagon Obstacle	145	7%	18.10 sec	9.37 sec
Standing Long Jump	125	6%	3.15m/3.75m	3.15m/3.75m
Double Leg Penta Jump	125	6%	13.5m	16.1m
Single Leg Penta Jump	125	6%	12.2m	13.9m
Max Push Ups (Tempo Imposed)	125	6%	70 reps	70 reps
Submaximal Squat	260	12%	45 reps	45 reps
Submaximal Deadlift	260	12%	45 reps	45 reps
Pull Ups	105	5%	25 reps	25 reps
Brutal Bench	161	8%	70 reps	70 reps
90 sec Box Jump	325	16%	110 reps	120 reps
Total Possible Points	2081			



ACA FITNESS COMBINE FIELD TESTS

AEROBIC CAPACITY & ENDURANCE

AIS 20m SHUTTLE-RUN (BEEP TEST)

Equipment:

- 30m Tape measure to determine the turning points
- Cones, marker chalk, or tape to clearly mark the turning points
- Speakers loud enough to hear the audio for the full length of the test in the space being used
- Audio device to play the Australian Institute of Sport 20m Shuttle-Run (Beep Test) audio file.
 - Follow the calibration instructions prior to every test and modify the running distance according to the table provided below.
- Large open space that is a flat, even surface (e.g., turf, track, court, dry asphalt, other flooring) that is at least 30 meters in length. Width is determined by how many athletes will be running at one time.
- To obtain the most accurate results, particularly if they are to be compared for the same subject over a period, the tests should be performed in as similar conditions as possible.

Audio: Australian Institute of Sport 20m Shuttle-Run (Beep Test)

Warm Up: Perform dynamic warm up that includes both flexibility and mobility exercises ahead of the specific warm up that is included in the first five (5) to ten (10) shuttles.

Protocol: The athlete will follow the instructions on the audio device and run to the sound of the beep until the athlete is no longer able to complete a level.

- Follow the audio directions for the correct protocol
- Mark out two lines, 20m apart on flat surface – preferably an indoor court or turf surface
- Check that the athlete has good footwear and that the surface/footwear is not excessively slick
- The test starts on the first beep. The athlete runs along the 20m space and gets to the opposite line in time with the beep and waits for the following beep (if necessary). The athlete then turns and runs back, getting back to the first line in time with the next beep.
- The beeps get closer together as the test progresses, requiring the athlete to run faster each stage. The test is a maximal test, and the athlete is encouraged to run in time with the beeps for as long as possible.
- The athlete must touch or cross the threshold of the line marking the 20m distance.
- When the athlete falls behind the beep, or they do not touch or cross the 20m threshold, a verbal warning is given. If they do not make it back before the subsequent beep, that athlete is asked to stop, and their score is recorded. The score recorded will be the last level that the athlete successfully achieved in time with the beep.
 - The athlete may miss the beep multiple times as long as they cross the opposite line on the next beep. Missing two consecutive beeps ends the test.
 - The athlete must run in time with the beep and do not run ahead of it. Running ahead of the beep gives the athlete extra time to make the subsequent beep and can cause additional fatigue.

Contraindications: Lower body injury that limits running performance.

Video: [AIS 20m Shuttle-Run](#)

Scoring: Record the last level completed by the athlete. If an athlete misses two (2) consecutive beeps before exiting the test, be careful to record the last completed level. For example, an athlete makes the beep at 11.3; misses the beep at 11.4 and misses the beep at 11.5 the last completed level is 11.3 and is recorded as the last completed level.



AIS 20m Shuttle Run (Beep Test) Benchmarks Female (stage, level)

Age	U10	U12	U14	U16	U18	U21+
Target Goal	7,2	9,2	10,2	11,5	11,9	12,5
Good	6,8	7,4	8,3	9,4	10,2	11,5
Needs Training	5,6	6,2	6,4	8,2	8,5	10,2

AIS 20m Shuttle Run (Beep Test) Benchmarks Male (stage, level)

Age (Men)	U10	U12	U14	U16	U18	U21+
Target Goal	8,2	9,2	11,6	12,8	13,10	15,8
Good	6,10	7,4	9,4	11,6	11,8	14,8
Needs Training	5,6	6,2	8,2	9,4	9,8	12,8



COORDINATION, CHANGE OF DIRECTION SPEED HEXAGONAL OBSTACLE

Equipment:

- Standard Hexagonal Obstacle
- Stopwatch
- Even, hard surface with good traction (e.g., turf, track, court, dry asphalt, other flooring)

Warm up: Since this test comes directly after the AIS 20m Shuttle-Run, the athletes should be thoroughly warmed up in general. Coaches may allow a specific hexagonal obstacle warm-up of two (2) to four (4) attempts.

Protocol: The goal is to jump through the obstacle as fast as possible with a two (2) foot landing in a hexagonal pattern.

- The starting position has the athlete with both feet on the inside of the obstacle next to the 20cm hurdle facing forward, between the 32cm and 35cm hurdle.
- The start command is “Ready...Go!”. Both the athlete and timekeeper start on “Go!”.
- At the start signal “Go!”, the athlete begins to jump with two (2) legs around the obstacle.
- An athlete attempt consists of two (2) rounds and the clock is stopped when the athlete lands back in the middle of the obstacle after the last jump over either the 32cm or 35cm hurdle, depending on the direction of travel.
- The test consists of a maximum of three (3) attempts, with a minimum of two (2) in each direction of travel.
 - An attempt is considered disqualified if the athlete contacts the hurdles. Note: there is an exception if the fault occurs on the first two (2) hurdles, it is a false start, and the athlete is allowed to repeat the attempt. Only one false start is authorized.
 - If the athlete starts before the start command, the athlete is disqualified, and the attempt stopped. If the athlete disqualifies on all three (3) attempts in one direction of travel, the score recorded will be zero (0).

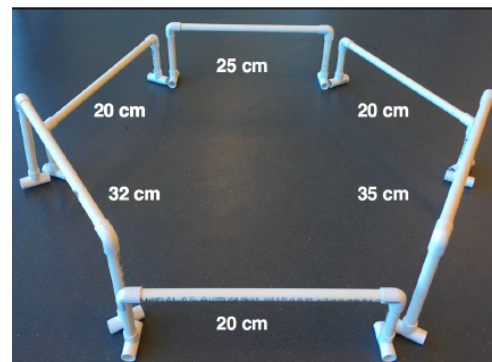
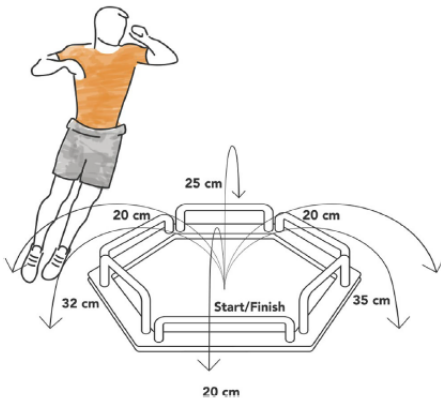

Contraindications: Lower body injury that prevents plyometric activity (jumping)

Video: [Hexagonal Obstacle](#)

Scoring: Record time from the start command to the completion of two revolutions when both feet return to the inside of the hexagonal obstacle. Best times in each direction, clockwise and counterclockwise, are combined and the combined time will be recorded as the final score.



Hex Specifications:

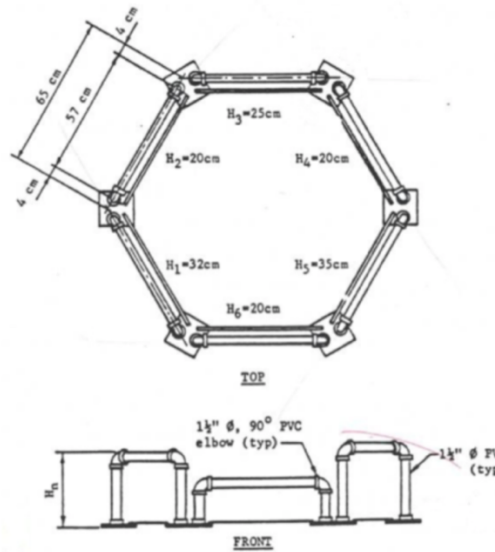

Hexagonal Obstacle Benchmarks Female (seconds):

Age	12	13	14	15	16	17	18	19	20	21	22	23	24	25	26	27+
Target Goal	23,00	22,31	21,63	21,00	20,45	20,02	19,69	19,46	19,29	19,15	19,06	19,00	19,00	19,00	19,00	19,00
Good	24,33	23,64	22,96	22,32	21,75	21,27	20,91	20,64	20,45	20,32	20,24	20,19	20,17	20,17	20,17	20,17
Needs Training	25,67	24,98	24,30	23,65	23,04	22,53	22,12	21,82	21,49	21,42	21,38	21,35	21,35	21,35	21,35	21,25

Hexagonal Obstacle Benchmarks Male (seconds):

Age	12	13	14	15	16	17	18	19	20	21	22	23	24	25	26	27+
Target Goal	22,00	21,48	20,98	20,51	20,10	19,74	19,43	19,17	18,96	18,79	18,65	18,55	18,47	18,42	18,40	18,40
Good	24,00	23,42	22,85	22,32	21,82	21,37	20,97	20,61	20,30	20,03	19,81	19,63	19,50	19,41	19,34	19,33
Needs Training	26,00	25,31	24,64	23,99	23,36	22,78	22,25	21,79	21,38	21,04	20,77	20,55	20,39	20,28	20,20	20,20



COORDINATION & AGILITY

MODIFIED HEXAGONAL AGILITY TEST – U12 and younger athletes

Equipment:

- Tape or chalk to create the hexagon lines on the ground
 - Length of each side = 60.5 cm
 - Angle between sides = 120° degrees
- Tape measure & Protractor
- Stopwatch
- Even, hard surface with good traction (e.g., turf, track, court, dry asphalt, other flooring)

Warm up: Since this test comes directly after the AIS 20m Shuttle-Run, the athletes should be thoroughly warmed up in general. Coaches may allow a specific hexagonal obstacle warm-up of two (2) to four (4) attempts.

Protocol: The goal is to jump through the obstacle as fast as possible with a two (2) foot landing in a hexagonal pattern.

- The starting position has the athlete with both feet on the inside of the obstacle.
- The start command is “Ready...Go!”. Both the athlete and timekeeper start on “Go!”.
 - At the start signal “Go!”, the athlete begins to jump with two (2) legs around the obstacle.
 - The athlete remains facing forwards as they jump around the hexagon.
- An athlete attempt consists of two (2) rounds and the clock is stopped when the athlete lands back in the middle of the obstacle after the last jump over the line depending on the direction of travel.
- The test consists of a maximum of three (3) attempts, with a minimum of two (2) in each direction of travel.
 - An attempt is considered disqualified if the athlete contacts the lines. Note: there is an exception if the fault occurs on the first two (2) hurdles, it is a false start, and the athlete is allowed to repeat the attempt. Only one false start is authorized.
 - If the athlete starts before the start command, the athlete is disqualified, and the attempt stopped. If the athlete disqualifieds on all three (3) attempts in one direction of travel, the score recorded will be zero (0).

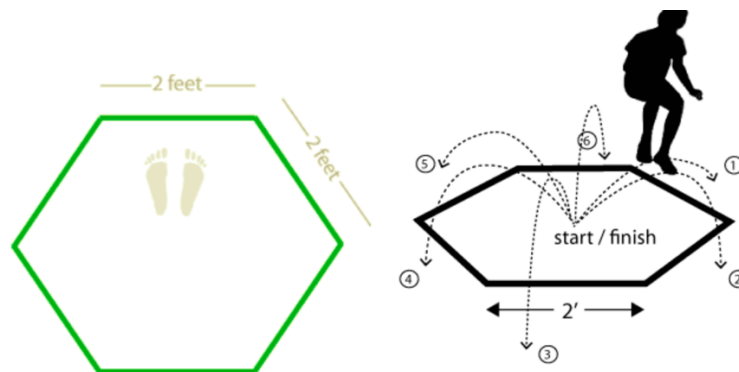

Contraindications: Lower body injury that prevents plyometric activity (jumping)

Scoring: Record time from the start command to the completion of two revolutions when both feet return to the inside of the hexagonal obstacle. Best times in each direction, clockwise and counterclockwise, are combined and the combined time will be recorded as the final score.



Modified Hexagonal Agility Test (seconds)

Age	8	9	10	11
Target Goal	9,00	9,50	9,40	9,30
Good	11,00	10,50	10,40	10,30
Needs Training	13,15	13,30	13,15	13,00



LOWER BODY POWER, FUNCTIONAL STRENGTH, AND COORDINATION STANDING LONG JUMP

Equipment:

- Metric tape measure
- Non-slip floor
- Masking or Athletic tape to clearly marked take-offline

Warm Up: Perform one (1) to three (3) submaximal repetitions. Feedback in relation to technique and implementation should be given during warm-up.

Protocol: The goal is to jump as far as possible with good technique, balance, and coordination.

- Place and secure the tape measure on flat ground on a non-slip surface.
- Place the edge of the tape at the zero (0) centimeter mark of the metric tape measure.
- The toes of the athlete are lined up with the edge of starting line at zero (0) centimeters.
- Using a two-foot (bilateral) take off, the athlete will perform a maximal effort jump with the goal of maximizing the horizontal jump distance.
- The athlete will land on two feet.
- Measure the distance from the starting line (0cm) to the rear contact point (heel) that is closest to the starting line.

The test consists of a minimum of three (3) attempts with a 20-second rest in between jumps. More than three (3) attempts are allowed if the athlete continue to increase the distance jumped.

Contraindications: Lower body injury that impairs vertical and horizontal jump performance.

Video: [Standing Long Jump](#)

Scoring: The longest jump distance is registered as the athlete's result.



Standing Long Jump Benchmarks Female (meters):

Age	8	9	10	11	12	13	14	15	16	17	18	19	20	21	22	23	24+
Target Goal	1.59	1.69	1.79	1.88	1.98	2.07	2.09	2.09	2.10	2.11	2.19	2.49	2.64	2.79	2.86	2.93	3.15
Good	1.48	1.58	1.68	1.78	1.88	1.98	2.00	2.01	2.03	2.04	2.11	2.19	2.34	2.49	2.64	2.79	2.93
Needs Training	1.34	1.37	1.44	1.50	1.57	1.63	1.67	1.67	1.69	1.72	1.85	1.86	1.89	2.04	2.11	2.19	2.34

Standing Long Jump Benchmarks Male (meters):

Age	8	9	10	11	12	13	14	15	16	17	18	19	20	21	22	23	24+
Target Goal	1.68	1.79	1.92	2.04	2.20	2.36	2.44	2.50	2.61	2.65	2.70	2.79	2.94	3.09	3.20	3.39	3.75
Good	1.57	1.63	1.81	1.93	2.00	2.16	2.30	2.41	2.50	2.61	2.65	2.70	2.79	2.94	3.09	3.20	3.39
Needs Training	1.39	1.49	1.58	1.67	1.70	1.86	2.00	2.11	2.28	2.41	2.50	2.61	2.65	2.70	2.79	2.94	3.19



LOWER BODY POWER, FUNCTIONAL SPEED-STRENGTH, BALANCE & COORDINATION

DOUBLE LEG PENTA JUMP

Equipment:

- Metric tape measure
- Non-slip floor
- Masking or Athletic tape to clearly marked take-offline

Warm up: Perform one (1) to three (3) submaximal repetitions. Feedback in relation to technique and implementation should be given during warm-up.

Protocol: The goal is to jump as far as possible five times with good technique, balance, and coordination.

- Place and secure the tape measure on flat ground on a non-slip surface.
- Place the edge of the tape at the zero (0) centimeter mark of the metric tape measure.
- The heels of the athlete are lined up with the edge of starting line at zero (0) centimeters.
- Using a two-foot (bilateral) take off, the athlete will perform five (5) “continuous” maximal effort jumps with the goal of maximizing the horizontal jump distance each jump.
 - Once the athlete begins, they must maintain their continuous movement forward. The results are not counted if the athlete pauses (rest) after each landing before the next take off.
- The athlete will land on two feet and must maintain balance. If the athlete moves forward or loses balance on landing the test result does not count and must be repeated.
- Measure the distance from the starting line (0cm) to the rear contact point (heel) that is closest to the starting line.

The test consists of a minimum of three (3) attempts with a 20-second rest in between jumps. In the event the athlete loses balance on landing, discard the result, and repeat the test.

Contraindications: Lower body injury that impairs vertical and horizontal jump performance.

Video: [Double Leg Penta Jump](#)

Scoring: The longest jump distance is registered as the athlete’s result.



Double Leg Penta Jump Benchmarks Female (meters):

Age	12	13	14	15	16	17	18	19	20	21	22	23	24	25	26+
Target Goal	9.0	10.5	10.5	10.8	11.0	11.2	11.3	11.6	12.2	12.3	12.5	12.6	12.7	12.9	13.1
Good	8.0	9.6	9.6	9.6	10.2	10.5	11.0	11.3	11.6	12.0	12.1	12.2	12.4	12.7	12.9
Needs Training	7.5	8.8	8.8	9.0	9.0	9.8	10.3	10.5	11.3	11.6	11.8	12.0	12.1	12.2	12.4

Double Leg Penta Jump Benchmarks Male (meters):

Age	12	13	14	15	16	17	18	19	20	21	22	23	24	25	26+
Target Goal	9.5	11.0	11.0	12.5	12.5	13.2	13.7	13.9	14.3	14.9	15.1	15.3	15.7	15.7	16.1
Good	8.0	10.0	10.0	11.7	11.7	12.0	12.5	12.9	13.3	12.0	14.9	15.1	15.3	15.3	15.7
Needs Training	7.5	9.0	9.0	11.0	11.0	11.3	11.8	12.1	12.5	11.6	12.8	13.2	13.5	13.9	14.3



LOWER BODY POWER, FUNCTIONAL SPEED-STRENGTH, BALANCE, COORDINATION & ASSYMETRY SINGLE LEG PENTA JUMP

Equipment:

- Metric tape measure
- Non-slip floor
- Masking or Athletic tape to clearly marked take-offline

Warm up: Perform one (1) to three (3) submaximal repetitions. Feedback in relation to technique and implementation should be given during warm-up.

Protocol: The goal is to jump as far as possible five times with good technique, balance, and coordination on a single leg.

- Place and secure the tape measure on flat ground on a non-slip surface.
- Place the edge of the tape at the zero (0) centimeter mark of the metric tape measure.
- The heels of the athlete are lined up with the edge of starting line at zero (0) centimeters and feet hip-width apart.
- Using a two-foot (bilateral) take off, the athlete will perform four (4) single leg “continuous” maximal effort jumps with the goal of maximizing the horizontal jump distance each jump landing with two feet (bilateral) on the last landing resulting in a total of five jumps.
 - First jump – bilateral (two-foot) take off
 - Jumps 2 – 4 = single leg being evaluated (L -or- R)
 - Landing after 4th jump = bilateral (two feet)
- The athlete will land on two feet (bilateral) and must maintain balance. If the athlete moves forward or loses balance on landing the test result does not count and must be repeated.
- Measure the distance from the starting line (0cm) to the rear contact point (heel) of the single leg being evaluated.

The test consists of a minimum of three (3) attempts with a 20-second rest in between jumps. In the event the athlete loses balance on landing, discard the result, and repeat the test.

Contraindications: Lower body injury that impairs vertical and horizontal jump performance.

Scoring: The longest jump distance for the right and left leg are registered as the athlete’s result. The result from both the left and right leg will be averaged to calculate combine points earned.

Common dysfunctions during the Penta Jump (double/single leg):

- It is important to observe technique and confidence in jumping.
 - Inward movement of a knee or both knees (dynamic valgus)
 - Thoracic collapse
 - Toeing out (external rotation)
 - Loss of neutral spine position
- Single leg Penta jump scores between left and right legs that differs by 50cm indicate significant strength, power, and coordination differences between sides.



Single Leg Penta Jump Benchmarks Female (meters):

Age	12	13	14	15	16	17	18	19	20+
Target Goal	7.76	8.36	9.35	9.76	10.21	10.69	10.92	11.13	11.37
Good	7.10	7.76	8.63	8.84	9.91	10.39	10.69	10.71	10.91
Needs Training	6.28	7.10	7.91	7.92	8.94	10.08	10.39	10.61	10.71

Single Leg Penta Jump Benchmarks Male (meters):

Age	12	13	14	15	16	17	18	19	20+
Target Goal	8.82	9.87	10.08	10.47	11.63	11.77	12.17	13.18	13.46
Good	8.01	8.60	8.81	9.43	10.51	10.74	11.63	12.37	12.80
Needs Training	7.20	7.33	7.80	8.22	9.27	10.26	10.60	11.56	12.14



UPPER BODY STRENGTH, CORE STABILIZATION, ENDURANCE & COORDINATION MAX PUSH UPS (TEMPO IMPOSED)

Equipment:

- Push-up audio file or metronome set to 20 BPM
- Speakers and device to play the audio file
- Flat surface

Warm up: Athlete must demonstrate the ability to stabilize the entire body while in the starting push-up position - plank (i.e., shoulder girdle, low back, and hips). Warm up exercises should include stretching of the wrist, elbows along with shoulder activation (i.e., I's, Y's, T's) and a couple of plank holds.

Protocol:

- The athlete starts in a prone plank position, at the top of a push up, with their hands on the ground in a self-selected position (recommended hands underneath or just outside of shoulder width), arms straight, fingers pointed forward, and legs straight, parallel, and slightly apart (2-4 inches) with toes positioned underneath the heel.
 - For injury considerations, an athlete may choose to perform the test on knuckles/fist.
- The push-up is completed in sync with the audio file, one push-up every 3 seconds (1.5s on the way down and 1.5s on the way up) and are continued until the athlete cannot continue at the required pace.
 - At the top, the athlete must begin the downward movement on the “down” command (push-up audio file).
 - At the bottom, the athlete must begin the upward movement on the “up” command (push-up audio file).
- The athlete must lower the body until the inside edges of the upper arm and forearm create a 90-degree angle of the elbow
 - Deeper than 90-degrees is acceptable if no other part of the body contacts the floor.
- The body should remain straight (shoulders, hips and knees aligned) during every rep, and the elbows must fully lock straight at the top.
- Continue push-ups on tempo, waiting for the command (up or down) until failure.
- The coach counts and records the number of satisfactorily completed 90-degree push-ups.
- The athlete completes as many satisfactory reps as possible.
- If an athlete misses three (3) consecutive reps in a row due to the lack of depth, alignment criteria, or missing tempo, the test is ended and the number of satisfactory reps up to that point are recorded.
- If an athlete purposefully skips a rep to rest, the test is ended.

Contraindications: Upper body, shoulder, wrists, and back injury that impairs the ability to stabilize and support the body.

Video: [Push Up Test Video](#)

Audio Link: [Push Up Test Audio Track](#)

Max Push Ups (Tempo Imposed) Benchmarks all athletes (repetitions):

Age	8	9	10	11	12	13	14	15	16	17	18	19	20	21+
Target Goal	18	20	25	30	34	41	41	46	50	50	52	54	57	60
Good	13	15	18	23	27	37	37	42	45	46	46	48	50	52
Needs Training	10	12	14	18	22	28	28	30	30	31	33	33	35	37



UPPER BODY STRENGTH, CORE STABILIZATION & COORDINATION PULL UPS (U14 & OLDER)

Equipment: A pull-up bar high enough for the tallest athletes to hang from without touching the ground with their feet pulled behind them at a minimum.

Warm up: Athlete performs three (3) to five (5) pull ups with a band for assistance. Optionally, athletes can complete five (5) pull downs on a pulley machine.

Protocol:

- The athlete grips the bar in a self-selected width (recommended just outside of shoulder width) with an overhand grip.
- The athlete begins the test from a hang with elbow in full extension and the shoulders, hips, knees, and ankle in one line.
- The athlete must pull their body until the height of the chin exceeds the height of the bar.
- The athlete will lower their body down to full extension, starting position. This will count as one repetition.
 - A repetition is not counted if:
 - There is any break in the alignment of the body that assists with leverage. This includes excessive movement in hips towards a pike and excessive back arching.
 - The athlete fails to pull to their chin above the bar
 - The athlete using a swinging motion or any other momentum to complete the repetition.
- The athlete is provided one attempt to complete as many pull ups as possible.

Contraindications: Upper body injury that limits pull up performance or a history of shoulder instability.

Scoring: Record the number of correctly completed repetitions.

Video: [Pull Up Test](#)



Pull Up Benchmarks Female (repetitions):

Age	12	13	14	15	16	17	18	19	20	21+
Target Goal	6	7	8	9	10	12	14	16	16	16
Good	3	5	6	7	8	10	12	14	14	14
Needs Training	1	2	3	4	5	6	7	8	8	8

Pull Up Benchmarks Male (repetitions):

Age	12	13	14	15	16	17	18	19	20	21+
Target Goal	12	14	16	17	18	18	18	18	18	18
Good	7	9	10	11	13	13	14	14	15	15
Needs Training	2	4	6	7	8	9	10	10	11	11



UPPER BODY STRENGTH, CORE STABILIZATION & COORDINATION FLEXED ARM BAR HANG – ALTERNATIVE TO PULL UP (U14 & YOUNGER)

Equipment:

- A pull-up bar high enough for the tallest athletes to hang from without touching the ground with their feet pulled behind them at a minimum.
- A stopwatch

Warm up: Athlete performs three (3) to five (5) pull ups with a band for assistance.

Protocol:

- The athlete grips the bar in a self-selected width (recommended just outside of shoulder width) with an overhand grip.
- Using a box, bench, or assistance to lift the athlete into the starting position where the athlete's chin is above the bar but not touching it; the arms are flexed.
- The athlete is instructed to hold their body motionless for as long as possible without letting their chin drop below the bar.
- The test concludes when the athletes chin dips below the bar.

Contraindications: Upper body injury that limits pull up performance or a history of shoulder instability.

Scoring: Record the total time the athlete holds their chin over the bar in seconds. Results from this test do not count toward the overall combine total score.

Bar Hang Benchmarks – Girls (seconds)

Age	8	9	10	11	12	13	14
Target Goal	26	35	38	37	39	42	60
Good	20	22	24	25	28	31	40
Needs Training	11	14	16	16	19	21	23

Bar Hang Benchmarks – Boys (seconds)

Age	8	9	10	11	12	13	14
Target Goal	34	40	48	52	54	58	68
Good	20	23	24	31	31	33	47
Needs Training	17	18	22	25	26	33	40

(Reiman, M.P. & Manske, R.C., 2009)



ABDOMINAL STRENGTH & ENDURANCE
SIT UPS – U14 and younger athletes

Equipment:

- Sit up audio file or a metronome set at 20 BPM
- Speakers and device to play the audio file
- Flat surface

Warm-up: Practice two (2) to five (5) repetitions ahead of starting the audio track

Protocol: The sit up test measures abdominal strength and endurance, which is important in back support and stability.

- The athlete begins by lying on their back, knees bent at approximately 140°, feet flat on the floor, arms straight and parallel to the trunk with palms of the hands resting on the mat. The fingers are stretched out and the head is in contact with the mat.
- The feet cannot be held or rest against an object.
- Always keeping heels in contact with the mat, the athlete curls up slowly, sliding their fingers along the mat until they have performed a full sit up.
 - Curl into the upright position by first lifting the head and neck, then lifting the thorax, then lumbar, and finally the pelvis regions.
- Reverse the curl up sequence to return to the mat until the head touches the mat.
 - Fingers remain sliding on the mat next to the body throughout the movement.
- Movement should be smooth at the cadence of one (1) sit up for every three (3) seconds, following the cadence on the audio file.
- The test continues until the athlete is exhausted, can no longer maintain the cadence with the audio track, or reaches 80 sit ups.
 - The test is stopped if the athlete has two technical warnings, examples of technical warnings include:
 - The heels detach from the ground
 - The head does not return to the mat
 - Ensuring that they are not hunching their shoulders as they sit up, their hands should passively move along the mat

Contraindications: Neck, back or abdominal neck injury.

Audio Track: <https://www.topendsports.com/testing/metronomes/sit-up.htm>
Scoring: Record the number of properly executed sit

ups. Sit Up Benchmarks – All Athletes (repetitions)

Age	8	9	10	11	12	13
Target Goal	35	45	47	50	51	53
Good	30	36	39	40	41	43
Needs Training	26	28	30	33	33	35



ABDOMINAL STRENGTH & ENDURANCE

BRUTAL BENCH

Equipment:

- Standard bench with foot holds, turned on end and secured to the wall the goal is to have the knees at 90°
- Mat or padding to go behind the knees
- Rope ring with about a five (5) centimeter diameter

Warm up: Two (2) to five (5) repetitions. Feedback in relation to technique and implementation should be given during the warmup.

Protocol: The goal is to complete as many repetitions as possible with the approved technique.

- Athletes will secure their feet into the foot hold and lower themselves down to the starting position with their full back lying on the bench, upside down with knees flexed at 90°
- The athlete will hold two fingers from each hand through a rope ring about five (5) centimeters placed behind the head. The ring is held throughout the test.
- The athlete will lower themselves all the way down to the bench and proceed to lift their upper body entirely up until the elbows touch the front of the knees and proceed to lower themselves back to bench in a controlled manner.
- The hip should always remain in contact with the bench.
 - The athlete must consciously relax the quadriceps muscles.
- When the athlete breaks form, the coach should notify the athlete and if the error continues, the repetitions do not count.
- When the problem persists for more than a couple of repetitions, the repetitions do not count, and the test is stopped.
- There is no time limit.
 - Rest periods are not allowed between repetitions (<1 sec between repetitions), neither at the top nor at the bottom of the movement.
 - If the break is longer than one (1) second, the athlete will receive a warning. The next time the athlete rests longer than one (1) second, the test is ended.

Contraindications: Neck, back or abdominal neck injury.

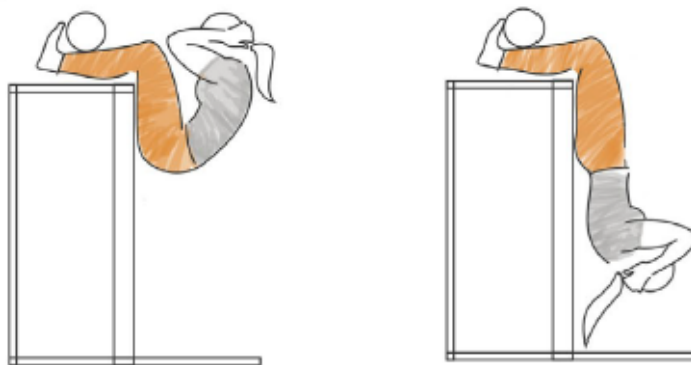

Scoring: Each time the athlete successfully touches their knees with the elbows, it is counted as one (1) repetition. Count the number of properly completed repetitions.

Video: [Brutal Bench](#)

Bench Specifications: The bench should be stable and attached to a pole or wall. Ideally, the bench should measure 75 cm high x 50 cm wide x 160 cm tall and should have padding below the knees and on top of the shins.



Brutal Bench Benchmarks All Athletes (repetitions):

Age	12	13	14	15	16	17	18	19	20	21+
Target Goal	11	12	13	14	15	16	17	18	19	20
Good	7	8	9	10	11	12	13	14	15	16
Needs Training	3	4	5	6	7	8	9	10	11	12



ANAEROBIC CAPACITY, AGILITY & COORDINATION

45/60/90 SECOND BOX JUMP

Equipment:

- Stopwatch
- Flat, even, non-slip surface
- Counter (suggested)
- A box meeting the specifications listed below
 - 40cm high for U16 and older
 - 30cm high for U12 and younger
 - There should be no sharp edges on the box.

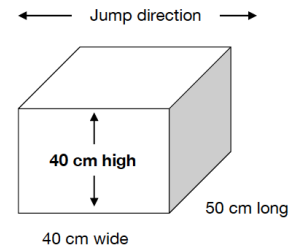

Warm Up: The athlete should perform 3-5 jumps each side with increasing intensity. Technical feedback should be provided during the warmup.

Protocol: The 90 second box jump test is a measure of speed, power, anaerobic endurance, and coordination specific to ski racing.

- The test is performed
 - 90 seconds of maximum jumping for U16 and older athletes (40cm box)
 - 60 seconds of maximum jumping for U14 athletes (40cm box)
 - 45 seconds of maximum jumping for U12 and younger athletes (30cm box)
- Two spotters sit on the floor with feet against the box to ensure stability of the box.
- To start, the athlete stands on top of the box, waiting for a count-down from 3-1.
- The timer shouts “go” and starts the stopwatch simultaneously.
- The athlete jumps down to the ground on one side of the box, keeping the feet within the box footprint.
- The athlete jumps laterally back and forth over the box, landing in the middle of the box and facing the same direction for the duration of the test.
- Each time the athlete lands on the top of the box, one jump is counted.
- Feet should stay side-by-side during the test, not splitting apart or offset
- Any excessive turning of the feet, knees, or torso will invalidate the rep
 - Reps will not be counted when the athlete faults by:
 - Landing with the balls of the feet behind (on in front) of the box footprint.
 - Turning the feet, hips, or body more than 45° degrees
 - Offsetting the feet, splitting them from a side-by-side position to a stagger
 - Landing on the box with only one foot or “gallops” upon landing on the box, with one foot landing striking at a different time than the other.
 - Double contacting the ground between box reps

Contraindications: Lower body injury that limits jumping performance and plyometric activity

Scoring: Record the total number of correctly performed jumps completed.

Video: [90 Seconds Box Jump Video](#)



90 Second Box Jump Benchmarks - Female (repetitions):

Age	12	13	14	15	16	17	18	19	20	21	22	23	24	25+
Target Goal	75	80	84	87	89	91	92	93	94	95	95	95	95	95
Good	58	62	67	71	75	78	81	84	86	87	88	89	90	90
Needs Training	40	45	50	55	60	65	70	74	77	80	81	82	83	85

90 Second Box Jump Benchmarks - Male (repetitions):

Age	12	13	14	15	16	17	18	19	20	21	22	23	24	25+
Target Goal	85	89	93	97	100	103	106	108	110	111	112	113	114	115
Good	70	75	85	90	94	97	100	102	103	104	105	105	105	105
Needs Training	50	56	62	67	73	78	83	86	90	92	94	95	95	95



60 Second Box Jump Benchmarks – Female (repetitions)

Age	12	13
Target Goal	75	80
Good	58	62
Needs Training	40	45

60 Second Box Jump Benchmarks – Male (repetitions)

Age	12	13
Target Goal	85	89
Good	70	75
Needs Training	50	56

45 Second Box Jump Benchmarks – all athletes (repetitions)

Age	8	9	10	11
Target Goal	30	36	39	42
Good	25	30	35	37
Needs Training	19	20	21	24



ACA FITNESS COMBINE GYM TESTS

LIFTING TECHNIQUE

SQUAT TECHNIQUE

Equipment:

- Squat stand/rack
- Wooden Dowel/10kg bar/15kg bar/ 20kg bar – dependent on age of athlete
- Weight plates
- Weight belt
- Minimum 2 people
 - One spotter
 - One observation of technique

Warm up: The warmup is the first part of the test submaximal squat test protocol:

- 3 sets of 10 – 12 reps
 - @ Body weight with narrow stance
 - @ Body weight with wide stance
 - @ Body weight with rod overhead
 - with dowel or 10-15kg bar (a lighter bar than used for testing)

Protocol: The goal is to provide athletes feedback in relation to their squat technique with a possible progression in load, age-dependent, as part of the warmup routine for the submaximal squat test. Good lifting technique is a priority. This evaluation does not earn points and is not included in the ACA Fitness Combine score.

- **Bar Type**
 - The bar type used during the technique evaluation should be adjusted to match everyone based on age and training history.
 - U10 – Wooden Dowel
 - U12 – Wooden Dowel or Junior Bar (10kg)
 - U14 – Junior Bar (10kg) Light Bar (15kg)
 - U16 and older – Light Bar (15kg) or Olympic Bar (20kg)
- **Test Load**
 - The test load gradually increases with age to create a natural progression to the full submaximal squat test as a 17-year-old athlete.
 - 12 – 14 years technique evaluated with 20kg bar x 4 – 5 reps
 - 15 years technique evaluated with 20kg bar x 20 reps
 - 16 years technique evaluated with 20kg bar + 10kg x 20 reps
- **Rack Set Up**
 - The rack should be set slightly lower than shoulder height
- **Back Squat Technique**
 - **Starting Position**
 - Grasp the bar with a closed, pronated grip. The actual width depends on the bar position
 - Step under the bar and position the feet parallel to each other
 - Place the bar in a balanced position on the upper back and shoulders
 - High bar position – the bar is placed at the base of the neck using a handgrip only slightly wider than shoulder width.
 - Low bar position – the bar is placed across the deltoids below the neck and on the back of the shoulders using a handgrip wider than shoulder width
 - Hands are as close as possible to shoulders with elbows pointing down to create a “W” position with your arms
 - Hold the chest up and out while tilting the head slightly up to ensure your eyes are looking straight ahead

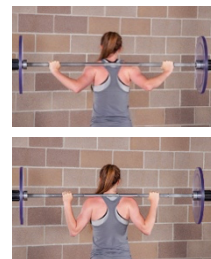

NSCA (2022)



- **Moving the Bar**
 - Once in position signal the spotter and observer and move the bar off the supports
 - Extend the hips and knees to lift the bar
 - Take one (1) to two (2) steps backwards
 - Position the feet shoulder width apart, or wider, but even with each other, with the toes pointed slightly outward
- **Downward Movement Phase**
 - Maintain a position with a neutral back and chest up and out
 - Allow the hips and knees to slowly flex while keeping the torso-to-floor angle relatively constant
 - Keep the heels on the floor and the knees aligned over the feet
 - Descend as far as possible while keeping the spine in a neutral position (slight curve in back)
 - Continue flexing the hips and knees until the knees are bent past 90°
- **Upward Movement Phase**
 - Maintain a position with a neutral back, chest up and out
 - Extend the hips and knees at the same rate to push the weight up
 - Keep the heels on the floor and knees aligned over the feet
 - Do not flex the torso forward or round the back
 - Continue extending the hips and knees to return to the starting position
- **Common Errors:**
 - Heels lifting off the floor – trying to keep back vertical (straight) by keeping the chest up and pushing through the heels.
 - A board can be placed under the heels to assist athletes lacking in ankle range of motion
 - Knees travelling excessively forward over toes
 - Bending at the waist and losing lordotic curve
 - Head and chest dropping



NSCA (2022)

Contraindications: Athlete does not have the full range of motion to execute proper technique, previous lower extremity injury, previous lower back injury not cleared by medical to participate.



LOWER BODY & CORE STRENGTH & ENDURANCE
SUBMAXIMAL SQUAT

Equipment:

- Squat stand/rack
- 20kg bar
- Weight plates
- Weight belt
- Minimum 4 people
 - Three (3) spotters
 - One (1) observing technique

Warm up: Rest of 1 – 2 mins during the weighted warm between sets.

- 3 sets of 10 – 12 reps
 - @ Body weight with narrow stance
 - @ Body weight with wide stance
 - @ Body weight with rod overhead
- 1 – 2 sets of 8-10 repetitions with unloaded bar
- 4 – 6 reps @ 30% of calculated weight (light warm up)
- 2 – 3 reps @ 45% of calculated weight
- 1 – 3 reps @ 60% of calculated weight
- 1 – 3 reps @ 75% of calculated weight

Protocol: The goal is to lift as many repetitions as possible with prescribed load with approved technique. As a safety precaution, all athletes are required to provide a training history that includes the sets and reps of the weight they have been lifting for the past four (4) weeks prior to participating in the submaximal squat test.

- Athletes can use a weight belt
- Knee wraps are not allowed

Load:

- Load is calculated by taking the athletes reported bodyweight in kilograms(kg) and then multiplying the athlete’s bodyweight (BW) by the bodyweight ratio listed in the chart and then adding that weight to their bodyweight.
 - Calculation example: BW x BW ratio + BW
 - In cases where the calculated test load is close to above the athletes predicted 1RM deadlift after reviewing the training history, 75% of their predicted 1RM can be used.

Age Category	Women Bodyweight Ratio	Men Bodyweight Ratio
U18	0.50x	0.75x
U21	0.75x	1.00x
U23	1.00x	1.25x
Senior	1.25x	1.50x

Good technique should always be a priority and each repetition should display good technique. When athletes can no longer execute good technique, the test is ended; this is not necessarily the point where they fail.

Contraindications: Athlete does not have the full range of motion to execute proper technique, previous lower extremity injury, previous lower back injury not cleared by medical to participate.



Submaximal Squat Benchmarks Female (repetitions)

Age	17	18	19	20	21+
Target Goal	14	19	24	28	30
Good	9	14	19	23	25
Needs Training	4	9	14	18	20

Submaximal Squat Benchmarks Male (repetitions)

Age	17	18	19	20	21+
Target Goal	14	19	24	28	30
Good	9	14	19	23	25
Needs Training	4	9	14	18	20



LIFTING TECHNIQUE DEADLIFT TECHNIQUE

Equipment:

- 10kg bar/15kg bar/ 20kg bar – dependent on age of athlete
- Weight plates
- Weight belt
- Minimum two (2) people
 - One (1) observer
 - One (1) spotter

Warm up: The warmup is part of the deadlift testing protocol.

Protocol: The goal is to provide athletes feedback in relation to their deadlift technique with a possible progression in load, age-dependent, as part of the warmup routine for the deadlift test. Good lifting technique is a priority. This evaluation does not earn points and is not included in the ACA Fitness Combine score.

- Lifting straps are not allowed
- **Bar Type**
 - The bar type used during the technique evaluation should be adjusted to match everyone based on age and training history.
 - U14 – Junior Bar (10kg) Light Bar (15kg)
 - U16 – Light Bar (15kg)
 - U18 and older – Olympic Bar (20kg)

- **Deadlift Technique**

- **Starting Position**

- Stand with the feet flat and placed between hip and shoulder width apart with the toes pointed slightly outward
- Squat down with the hips lower than the shoulders, and grasp the bar with a closed, alternated grip
- Place the hands on the bar slightly wider than shoulder width apart, outside the knees, with elbows fully extended, hold the scapulae down while stabilizing the trunk
- Place the feet flat on the floor and position the bar approximately three (3) centimeters in front of the shins and over the balls of the feet.
- Squat down keeping normal curve in lumbar spine, chest up, head facing forwards with eyes focused straight ahead or slightly up while maintaining shoulders over the bar

- **Upward Movement Phase**

- Push through the floor with the legs resulting in the extension of the knees and hips
- The knees and hips should rise at the same rate
- Do not let the hips rise before the shoulders
- As the bar rises, keep the bar close to the shins as possible
- When the bar clears the knees, move the hips forward to move the thighs against and the knees under the bar
- Continue to extend the hips and knees until the body is fully upright

- **Downward Movement Phase**

- Lower the bar under control keeping lower back slightly curved and the bar close to the body until the plates lightly touch the ground

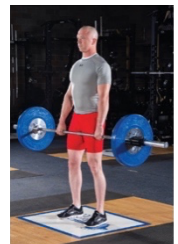
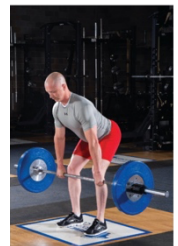
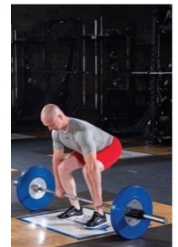

NSCA (2022)



- **Common Errors:**

- Poor posture at starting position of movement: lower back is rounded, head and chest forward
- Bar is too far in front of the feet
- Shoulders are not over the bar
- Bending arms to help pull the bar up
- Hips rising faster than knees
- Bar is too far in front of the body after the bar has cleared the knees
- Rounding the lower back at any stage of the lift
- Hyperextending the lower back at the top of the lift
- Head and chest dropping forward during descent phase of the lift

Contraindications: Athlete does not have the full range of motion to execute proper technique, previous lower extremity injury, previous lower back injury, or wrist injury not cleared by medical to participate.



LOWER BODY & CORE STRENGTH & ENDURANCE SUBMAXIMAL DEADLIFT

Equipment:

- 20kg bar
- Weight plates
- Weight belt
- Minimum three (3) people
 - Two (2) spotters
 - One (1) observing technique

Warm up: Rest of 1 – 2 mins during the weighted warm between sets.

- 3 sets of 10 – 12 reps
 - @ Bodyweight squats with narrow stance
 - @ Bodyweight squats with wide stance
- 1 – 2 sets of 8-10 repetitions with unloaded bar
- 4 – 6 reps @ 30% of calculated weight (light warm up)
- 2 – 3 reps @ 45% of calculated weight
- 1 – 3 reps @ 60% of calculated weight
- 1 – 3 reps @ 75% of calculated weight

Protocol: The goal is to lift as many repetitions as possible with prescribed load with approved technique. As a safety precaution, all athletes are required to provide a training history that includes sets and reps of the weight they have been lifting for the past four (4) weeks prior to participating in the submaximal deadlift test.

Load:

- Load is calculated by taking the athletes reported bodyweight in kilograms(kg) and then multiplying the athlete's bodyweight (BW) by the bodyweight ratio listed in the chart and then adding that weight to their bodyweight.
 - Calculation example: $BW \times BW \text{ ratio}$
 - In cases where the calculated test load is close to above the athletes predicted 1RM deadlift after reviewing the training history, 75% of their predicted 1RM can be used.

Age Category	Women Bodyweight Ratio	Men Bodyweight Ratio
U18	1.00x	1.25x
U21	1.25x	1.50x
U23	1.50x	1.75x
Senior	1.75x	2.00x

Good technique should always be a priority and each repetition should display good technique. When athletes can no longer execute good technique, the test is ended; this is not necessarily the point where they fail.

Contraindications: Athlete does not have the full range of motion to execute proper technique, previous lower extremity injury, previous lower back injury, or wrist injury not cleared by medical to participate.



Submaximal Deadlift Benchmarks Female (Repetitions)

Age	17	18	19	20	21+
Target Goal	14	19	24	28	30
Good	9	14	19	23	25
Needs Training	4	9	14	18	20

Submaximal Deadlift Benchmarks Male (repetitions)

Age	17	18	19	20	21+
Target Goal	14	19	24	28	30
Good	9	14	19	23	25
Needs Training	4	9	14	18	20



REFERENCES

- Alpine Canada Alpin. (2016) Alpine Canada Fitness Testing – Fall 2016 (English). Accessed at: https://ltad.alpinecanada.org/uploads/documents/ACA_Fitness_Testing_Protocol_-_final_draft.pdf
- Alpine Canada Alpin. (2016) Protocoles d'évaluation de la condition physique de Canada Alpin – Automne 2016 (French). Accessed at: https://ltad.alpinecanada.org/uploads/documents/ACA_Fitness_Testing_Protocol_-_final_fr_rev.pdf
- Andersen RE, Montgomery DL, and Turcotte RA. An on-site test battery to evaluate giant slalom skiing performance. *J Sports Med Phys Fitness* 30: 276-282, 1990.
- Brady S, DeCouto, Brad Fawver, Troy Taylor & Andrew Mark Williams (2021) Physical fitness is associated with better technical performance in adolescent alpine ski racers after controlling for practice time: A retrospective regression analysis, *Journal of Sports Sciences*, 39:4, 380-387. DOI: [10.1080/02640414.2020.1823088](https://doi.org/10.1080/02640414.2020.1823088)
- Bompa, T. *Total Training for Young Champions: Proven conditioning programs for athletes ages 6 to 18*. 2000, Champaign, IL: Human Kinetics.
- Dzimbova, Tatyana & Kirkova, Maria. (2020). Original Article Impact of training and competitions in alpine skiing on the anaerobic capacity of adolescent athletes. 2628-2636. [10.7752/jpes.2020.05358](https://doi.org/10.7752/jpes.2020.05358).
- Gilgien, Matthias & Reid, Robert & Raschner, Christian & Supej, Matej & Holmberg, Hans-Christer. (2018). The Training of Olympic Alpine Ski Racers. *Frontiers in Physiology*. 9. [10.3389/fphys.2018.01772](https://doi.org/10.3389/fphys.2018.01772).
- Gorski, T., Rosser, T., Hoppeler, H, and Vogt, M. (2013). An Anthropometric and Physical Profile of Young Swiss Alpine Skiers Between 2004 and 2011. *International Journal of Sports Physiology and Performance*. 9(1) DOI: [10.1123/IJSP.2013-0223](https://doi.org/10.1123/IJSP.2013-0223).
- Gross, M., Hoppeler, H., and Vogt, M. (2014). Quantification of the Metabolic and Physical Demands of the 90-Second Box Jump. *Journal of Athletic Enhancement*. 3:1. DOI: [10.4172/2324-9080.1000138](https://doi.org/10.4172/2324-9080.1000138).
- Gross, M., Hemund, K, and Vogt, M. (2013). High Intensity Training and Energy Production During 90-Second Box Jump in Junior Alpine Skiers. *Journal of Strength and Conditioning Research*. 28(6) DOI: [10.1519/JSC.000000000000294](https://doi.org/10.1519/JSC.000000000000294)
- Harris, J. & Cale, L (2006). A Review of Children's Fitness Testing. *European Physical Education Review*. 12(2): p. 201-225. DOI: [10.1177/1356336X06065359](https://doi.org/10.1177/1356336X06065359).
- Lloyd RS, Cronin JB, Faigenbaum AD, Haff GG, Howard R, Kraemer WJ, Micheli LJ, Myer GD, Oliver JL. (2016) National Strength and Conditioning Association Position Statement on Long-Term Athletic Development. *J Strength Cond Res*. 2016 Jun;30(6):1491-509. https://www.nscs.com/education/articles/NSCA_Position_Statement_on_LTAD/.
- Müller, L., Hildebrandt, C., Müller, E., Fink, C. & Raschner, C. (2017). Long-Term Athletic Development in Youth Alpine Ski Racing: The Effect of Physical Fitness, Ski Racing Technique, Anthropometrics and Biological Maturity Status on Injuries. *Frontiers in Physiology*. <https://doi.org/10.3389/fphys.2017.00656>.
- Maffioletti, N., et al. (2009). Physiological profile of Swiss Elite Alpine Skiers – a 10-year Longitudinal Comparison. *Science and Skiing IV*, E. Müller, S. Lindinger, and T. Stoggl, Editors, Meyer & Meyer Sport (UK) Ltd: London.
- Moseid, Christine & Myklebust, Grethe & Slaastuen, Marit & Bar-Yaacov, Jonathan & Kristiansen, Aase & Fagerland, Morten & Bahr, Roald. (2019). The Association between Physical Fitness Level and Rate and Severity of Injury and Illness in Youth Elite Athletes. *Scandinavian Journal of Medicine & Science in Sports*. 29. [10.1111/sms.13498](https://doi.org/10.1111/sms.13498).



National Strength & Conditioning Association (U.S.). *Exercise Technique Manual for Resistance Training/NSCA 4th Edition*. Champaign, IL: Human Kinetics, 2022.

Neumayer, G., et al. (2003). Physical and Physiological Factors Associated with Success in Professional Alpine Skiing. *International Journal of Sports Medicine*. 24: p.571-575. [DOI: 10.1055/s-2003-43270](https://doi.org/10.1055/s-2003-43270).

Norges Skiforbund Olympiatoppen. *Ironman Testbatteriene - Versjon 5.0, 14.aug 2014*.
https://www.skiforbundet.no/contentassets/5e6a8dc665e44eb0a6d7c6bde48e1a7/ironmanprotokoller_ver5_140813.pdf

Patterson, C., Raschner, C., and Platzer, H. (2009). Power variables and bilateral force differences during unloaded and loaded squat jumps in high performance alpine ski racers. *Journal of Strength and Conditioning Research*. 23(3): p 779-787 [DOI: 10.1519/JSC.0b013e3181a2d7b3](https://doi.org/10.1519/JSC.0b013e3181a2d7b3).

Plowman, S.A. & Meredith, M.D. (Eds.). (2013). *Fitnessgram/Activitygram Reference Guide (4th Edition)*. Dallas, TX: The Cooper Institute. Accessed at: <https://www.cooperinstitute.org/vault/2440/web/files/662.pdf>

Raschner, C., Müller, L., Patterson, C., Platzer, H. P., Ebenbichler, C., Luchner, R., et al. (2013). Current performance testing trends in junior and elite Austrian alpine ski, snowboard, and ski cross racers. *Sport. Orthop. Traumatol*. 29, 193–202. [doi: 10.1016/j.orthtr.2013.07.016](https://doi.org/10.1016/j.orthtr.2013.07.016).

R Turnbull, J & Kilding, Andrew & Keogh, Justin. (2009). Physiology of alpine skiing. *Scandinavian journal of medicine & science in sports*. 19. 146-55. [10.1111/j.1600-0838.2009.00901.x](https://doi.org/10.1111/j.1600-0838.2009.00901.x).

Stricker, P. R., Faigenbaum, A. D., McCambridge, T. M., Council of Sports Medicine and Fitness – Resistance Training for Children and Adolescents. *American Academy of Pediatrics*. 2020;145.
<https://publications.aap.org/pediatrics/article/145/6/e20201011/76942/Resistance-Training-for-Children-and-Adolescents?searchresult=1>

Tanner RK and Gore CJ. *Physiological Tests for Elite Athletes*. Champaign, IL: Human Kinetics, 2013.

Unknown, BC Alpine Ski Association Physical Fitness Testing Protocol – Revised 2014. *BC Alpine*. Accessed at: https://teampages.s3.amazonaws.com/documents/152321/BCA_Fitness_Test_Protocol.pdf?X-Amz-Algorithm=AWS4-HMAC-SHA256&X-Amz-Credential=AKIA3I4H7LHCQ6DJVXE%2F20220911%2Fus-east-1%2Fs3%2Faws4_request&X-Amz-Date=20220911T170845Z&X-Amz-Expires=21600&X-Amz-SignedHeaders=host&X-Amz-Signature=27a4076be1d14c2cc128296241112df627fd63221b89fd9c8858879c555a760a

U.S. Ski and Snowboard SkillsQuest-Fitness Manual. (2020). *U.S. Ski & Snowboard Website*.
https://usskiandsnowboard.org/sites/default/files/files-resources/files/2020/SkillsQuest-Fitness%20Manual%202020_0.pdf

Vernillo Gianluca, Coulmy Nicolas, Millet Grégoire P. (2019). Editorial: Recent Evolutions and Perspectives in Olympic Winter Sports Performance: To PyeongChang and Beyond...*Frontiers in Physiology*.10. p.481.
<https://www.frontiersin.org/article/10.3389/fphys.2019.00481>. [DOI=10.3389/fphys.2019.00481](https://doi.org/10.3389/fphys.2019.00481)
[ISSN=1664-042X](https://www.frontiersin.org/journal/10.3389/fphys).

Vogt, M., Glycogen Utilization and Composition of Skeletal Muscle in Elite Junior Alpine Skier – Study Presentation “Allain 2000”. 2000: Saas Fee/Leukerbad.

Vogt, M., Jordan, K., Spring, H., Hoppeler, H. (2003). Muscle Physiology and Determinants of Performance in Elite Alpine Skiers. *Medicine & Science in Sports & Exercise*. 35(5) p. S93. [DOI: 10.1097/00005768-200305001-00511](https://doi.org/10.1097/00005768-200305001-00511)



APPENDIX A SCORING TABLES

AIS 20m SHUTTLE-RUN (BEEP TEST)

Level Shuttle	Est VO ₂ Max	Points	Level Shuttle	Est VO ₂ Max	Points	Level Shuttle	Est VO ₂ Max	Points
4,4	27.6	0	8,5	41.5	107	11,11	53.4	221
4,5	28	0	8,6	41.8	110	11,12	53.7	223
4,6	28.3	0	8,7	42.1	113	12,1	54	226
4,7	28.7	1	8,8	42.4	116	12,2	54.3	229
4,8	29.1	4	8,9	42.6	119	12,3	54.5	232
4,9	29.5	7	8,10	42.8	122	12,4	54.8	234
5,1	29.9	10	8,11	43.3	125	12,5	55.4	237
5,2	30.2	13	9,1	43.6	128	12,6	55.7	240
5,3	30.6	15	9,2	43.9	131	12,7	55.9	243
5,4	31	18	9,3	44.2	133	12,8	56	245
5,5	31.4	21	9,5	44.9	139	12,9	56.2	248
5,6	31.8	24	9,6	45.2	142	12,10	56.5	251
5,7	32.4	27	9,7	45.5	145	12,11	56.8	254
5,8	32.7	30	9,8	45.8	148	12,12	57.1	256
5,9	32.9	33	9,9	46.3	151	13,1	57.4	259
6,1	33.3	36	9,10	46.6	154	13,2	57.6	262
6,2	33.6	39	9,11	46.8	157	13,3	57.9	265
6,3	34	42	10,1	47.1	160	13,4	58.2	267
6,4	34.3	45	10,2	47.4	163	13,5	58.5	270
6,5	34.7	48	10,3	47.7	166	13,6	58.7	273
6,6	35	51	10,4	48	168	13,7	59	276
6,7	35.4	54	10,5	48.4	171	13,8	59.3	278
6,8	35.7	57	10,6	48.8	174	13,9	59.6	281
6,9	36.1	60	10,7	49	177	13,10	59.8	284
6,10	36.4	63	10,8	49.3	179	13,11	60	287
7,1	36.8	66	10,9	49.5	182	13,12	60.2	289
7,2	37.1	69	10,10	49.8	185	13,13	60.6	292
7,3	37.5	72	10,11	50.2	188	14,2	61.1	295
7,4	37.8	74	10,12	50.4	190	14,4	61.7	298
7,5	38.2	77	11,1	50.5	193	14,6	62.6	300
7,6	38.5	80	11,2	50.8	196	14,8	62.7	303
7,7	38.5	83	11,3	51.1	199	14,10	63.2	306
7,8	39.2	86	11,4	51.4	201	14,13	64	309
7,9	39.6	89	11,5	52.2	204	15,2	64.6	311
7,10	39.9	92	11,6	51.9	207	15,4	65.1	314
8,1	40.2	95	11,7	52.2	210	15,6	65.6	317
8,2	40.5	98	11,8	52.5	212	15,8	66.2	320
8,3	40.8	101	11,9	52.8	215	15,10	66.7	322
8,4	41.1	104	11,10	53.1	218	15,13	67.5	325



HEXAGONAL OBSTACLE FEMALE U16+

Hex Combined Time (sec)	Combine Points
23.88 - 23.85	1
23.84 - 23.81	2
23.80 - 23.77	3
23.76 - 23.73	4
23.72 - 23.69	5
23.68 - 23.65	6
23.64 - 23.61	7
23.60 - 23.57	8
23.56 - 23.53	9
23.52 - 23.49	10
23.47 - 23.45	11
23.44 - 23.41	12
23.40 - 23.37	13
23.36 - 23.33	14
23.32 - 23.29	15
23.28 - 23.25	16
23.24 - 23.21	17
23.20 - 23.17	18
23.16 - 23.13	19
23.12 - 23.09	20
23.08 - 23.05	21
23.04 - 23.01	22
23.00 - 22.97	23
22.96 - 22.93	24
22.92 - 22.89	25
22.88 - 22.85	26
22.84 - 22.81	27
22.80 - 22.77	28
22.76 - 22.73	29
22.72 - 22.69	30
22.68 - 22.65	31
22.64 - 22.61	32
22.60 - 22.57	33
22.56 - 22.53	34
22.52 - 22.49	35
22.48 - 22.45	36
22.44 - 22.41	37
22.40 - 22.37	38
22.36 - 22.33	39
22.32 - 22.29	40
22.28 - 22.25	41
22.24 - 22.21	42
22.20 - 22.17	43
22.16 - 22.13	44
22.12 - 22.09	45
22.08 - 22.05	46
22.04 - 22.01	47
22.00 - 21.97	48
21.96 - 21.93	49
21.92 - 21.89	50

Hex Combined Time (sec)	Combine Points
21.88 - 21.85	51
21.84 - 21.81	52
21.80 - 21.77	53
21.76 - 21.73	54
21.72 - 21.69	55
21.68 - 21.65	56
21.64 - 21.61	57
21.60 - 21.57	58
21.56 - 21.53	59
21.52 - 21.49	60
21.48 - 21.45	61
21.44 - 21.41	62
21.40 - 21.37	63
21.36 - 21.33	64
21.32 - 21.29	65
21.28 - 21.25	66
21.24 - 21.21	67
21.20 - 21.17	68
21.16 - 21.13	69
21.12 - 21.09	70
21.08 - 21.05	71
21.04 - 21.01	72
21.00 - 20.97	73
20.96 - 20.93	74
20.92 - 20.89	75
20.88 - 20.85	76
20.84 - 20.81	77
20.80 - 20.77	78
20.76 - 20.73	79
20.72 - 20.69	80
20.68 - 20.65	81
20.64 - 20.61	82
20.60 - 20.58	83
20.56 - 20.53	84
20.52 - 20.49	85
20.48 - 20.45	86
20.44 - 20.41	87
20.40 - 20.37	88
20.36 - 20.33	89
20.32 - 20.29	90
20.28 - 20.25	91
20.24 - 20.21	92
20.20 - 20.17	93
20.16 - 20.13	94
20.12 - 20.09	95
20.08 - 20.05	96
20.04 - 20.01	97
20.00 - 19.97	98
19.96 - 19.93	99
19.92 - 19.89	100

Hex Combined Time (sec)	Combine Points
19.88 - 19.85	101
19.84 - 19.81	102
19.80 - 19.77	103
19.76 - 19.73	104
19.72 - 19.69	105
19.68 - 19.65	106
19.64 - 19.61	107
19.60 - 19.57	108
19.56 - 19.53	109
19.52 - 19.49	110
19.48 - 19.45	111
19.44 - 19.41	112
19.40 - 19.37	113
19.36 - 19.33	114
19.32 - 19.29	115
19.28 - 19.25	116
19.24 - 19.21	117
19.20 - 19.17	118
19.16 - 19.13	119
19.12 - 19.09	120
19.08 - 19.05	121
19.04 - 19.01	122
19.00 - 18.97	123
18.96 - 18.93	124
18.92 - 18.89	125
18.88 - 18.85	126
18.84 - 18.81	127
18.80 - 18.77	128
18.76 - 18.73	129
18.72 - 18.69	130
18.68 - 18.65	131
18.64 - 18.61	132
18.60 - 18.57	133
18.56 - 18.53	134
18.52 - 18.49	135
18.48 - 18.45	136
18.44 - 18.41	137
18.40 - 18.37	138
18.36 - 18.33	139
18.32 - 18.29	140
18.28 - 18.25	141
18.24 - 18.21	142
18.20 - 18.17	143
18.16 - 18.13	144
18.12 - 18.10	145



HEXAGONAL OBSTACLE MALE U16+

Hex Combined Time (sec)	Combine Points
23.18 - 23.15	1
23.14 - 23.11	2
23.10 - 23.07	3
23.06 - 23.03	4
23.02 - 22.99	5
22.98 - 22.95	6
22.94 - 22.91	7
22.90 - 22.87	8
22.86 - 22.83	9
22.82 - 22.79	10
22.78 - 22.75	11
22.74 - 22.71	12
22.70 - 22.67	13
22.66 - 22.63	14
22.62 - 22.59	15
22.58 - 22.55	16
22.54 - 22.51	17
22.50 - 22.47	18
22.46 - 22.43	19
22.42 - 22.39	20
22.38 - 22.35	21
22.34 - 22.31	22
22.30 - 22.27	23
22.26 - 22.23	24
22.22 - 22.19	25
22.18 - 22.15	26
22.14 - 22.11	27
22.10 - 22.07	28
22.06 - 22.03	29
22.02 - 21.99	30
21.98 - 21.95	31
21.94 - 21.91	32
20.90 - 21.87	33
21.86 - 21.83	34
21.82 - 21.79	35
21.78 - 21.75	36
21.74 - 21.71	37
21.70 - 21.67	38
21.66 - 21.63	39
21.62 - 21.59	40
21.58 - 21.55	41
21.54 - 21.51	42
21.50 - 21.47	43
21.46 - 21.43	44
21.42 - 21.39	45
21.38 - 21.35	46
21.34 - 21.31	47
21.30 - 21.27	48
21.26 - 21.23	49
21.22 - 21.19	50

Hex Combined Time (sec)	Combine Points
21.18 - 21.15	51
21.14 - 21.11	52
21.10 - 21.07	53
21.06 - 21.03	54
21.02 - 20.99	55
20.98 - 20.95	56
20.94 - 20.91	57
20.90 - 20.87	58
20.86 - 20.83	59
20.82 - 20.79	60
20.78 - 20.75	61
20.74 - 20.71	62
20.70 - 20.67	63
20.66 - 20.63	64
20.62 - 20.59	65
20.58 - 20.55	66
20.54 - 20.51	67
20.50 - 20.47	68
20.46 - 20.43	69
20.42 - 20.39	70
20.38 - 20.35	71
20.34 - 20.31	72
20.30 - 20.27	73
20.26 - 20.23	74
20.22 - 20.19	75
20.18 - 20.15	76
20.14 - 20.11	77
20.10 - 20.07	78
20.06 - 20.03	79
20.02 - 19.99	80
19.98 - 19.95	81
19.94 - 19.91	82
19.90 - 19.87	83
19.86 - 19.83	84
19.82 - 19.79	85
19.78 - 19.75	86
19.74 - 19.71	87
19.70 - 19.67	88
19.66 - 19.63	89
19.62 - 19.59	90
19.58 - 19.55	91
19.54 - 19.51	92
19.50 - 19.47	93
19.46 - 19.43	94
19.42 - 19.39	95
19.38 - 19.35	96
19.34 - 19.31	97
19.30 - 19.27	98
19.26 - 19.23	99
19.22 - 19.19	100

Hex Combined Time (sec)	Combine Points
19.18 - 19.15	101
19.14 - 19.11	102
19.10 - 19.07	103
19.06 - 19.03	104
19.02 - 18.99	105
18.98 - 18.95	106
18.94 - 18.91	107
18.90 - 18.87	108
18.86 - 18.83	109
18.82 - 18.79	110
18.78 - 18.75	111
18.74 - 18.71	112
18.70 - 18.67	113
18.66 - 18.63	114
18.62 - 18.59	115
18.58 - 18.55	116
18.54 - 18.51	117
18.50 - 18.47	118
18.46 - 18.44	119
18.42 - 18.39	120
18.38 - 18.35	121
18.34 - 18.31	122
18.30 - 18.27	123
18.26 - 18.23	124
18.22 - 18.19	125
18.18 - 18.15	126
18.14 - 18.11	127
18.10 - 18.07	128
18.06 - 18.03	129
18.02 - 17.99	130
17.98 - 17.95	131
17.94 - 17.91	132
17.90 - 17.87	133
17.86 - 17.83	134
17.82 - 17.79	135
17.78 - 17.75	136
17.74 - 17.71	137
17.70 - 17.67	138
17.66 - 17.63	139
17.62 - 17.59	140
17.58 - 17.55	141
17.54 - 17.51	142
17.50 - 17.47	143
17.46 - 17.43	144
17.42 - 17.40	145



HEXAGONAL OBSTACLE U14 ALL ATHLETES

Hex Combined Time (sec)	Combine Points
26.38 - 26.35	1
25.34 - 26.31	2
26.30 - 26.27	3
26.26 - 26.23	4
26.22 - 26.19	5
26.18 - 26.15	6
26.14 - 26.11	7
26.10 - 26.07	8
26.06 - 26.03	9
26.02 - 25.99	10
25.93 - 25.95	11
25.94 - 25.91	12
25.90 - 25.87	13
25.86 - 25.83	14
25.82 - 25.79	15
25.78 - 25.75	16
25.74 - 25.71	17
25.70 - 25.67	18
25.66 - 25.63	19
25.62 - 25.59	20
25.58 - 25.55	21
25.54 - 25.51	22
25.50 - 25.47	23
25.46 - 25.43	24
25.42 - 25.39	25
25.38 - 25.35	26
25.34 - 25.31	27
25.30 - 25.27	28
25.26 - 25.23	29
25.22 - 25.19	30
25.18 - 25.15	31
25.14 - 25.11	32
25.10 - 25.07	33
25.06 - 25.03	34
25.02 - 24.99	35
24.98 - 24.95	36
24.94 - 24.91	37
24.90 - 24.87	38
24.86 - 24.83	39
24.82 - 24.79	40
24.78 - 24.75	41
24.74 - 24.71	42
24.70 - 24.67	43
24.66 - 24.63	44
24.62 - 24.59	45
24.58 - 24.55	46
24.54 - 24.51	47
24.50 - 24.47	48
24.46 - 24.43	49
24.42 - 24.39	50

Hex Combined Time (sec)	Combine Points
24.38 - 24.35	51
24.34 - 24.31	52
24.30 - 24.27	53
24.26 - 24.23	54
24.22 - 24.19	55
24.18 - 24.15	56
24.14 - 24.11	57
24.10 - 24.07	58
24.06 - 24.03	59
24.02 - 23.99	60
23.98 - 23.95	61
23.94 - 23.91	62
23.90 - 23.87	63
23.86 - 23.83	64
23.82 - 23.79	65
23.78 - 23.75	66
23.74 - 23.71	67
23.70 - 23.67	68
23.66 - 23.63	69
23.62 - 23.59	70
23.58 - 23.55	71
23.54 - 23.51	72
23.50 - 23.47	73
23.46 - 23.43	74
23.42 - 23.39	75
23.38 - 23.35	76
23.34 - 23.31	77
23.30 - 23.27	78
23.26 - 23.23	79
23.22 - 23.19	80
23.18 - 23.15	81
23.14 - 23.11	82
23.10 - 23.07	83
23.06 - 23.03	84
23.02 - 22.99	85
22.98 - 22.95	86
22.94 - 22.92	87
22.90 - 22.87	88
22.86 - 22.83	89
22.82 - 22.79	90
22.78 - 22.75	91
22.74 - 22.71	92
22.70 - 22.67	93
22.66 - 22.63	94
22.62 - 22.59	95
22.58 - 22.55	96
22.54 - 22.51	97
22.50 - 22.47	98
22.46 - 22.43	99
22.42 - 22.39	100

Hex Combined Time (sec)	Combine Points
22.39 - 23.35	101
22.34 - 22.31	102
22.30 - 22.27	103
22.26 - 22.23	104
22.22 - 22.19	105
22.18 - 22.15	106
22.14 - 22.11	107
22.10 - 22.07	108
22.06 - 22.03	109
22.02 - 21.99	110
21.98 - 21.95	111
21.94 - 21.91	112
21.90 - 21.87	113
21.86 - 21.83	114
21.82 - 21.79	115
21.78 - 21.75	116
21.74 - 21.71	117
21.70 - 21.67	118
21.66 - 21.63	119
21.62 - 21.59	120
21.58 - 21.55	121
21.54 - 21.51	122
21.50 - 21.47	123
21.46 - 21.43	124
21.42 - 21.39	125
21.38 - 21.35	126
21.34 - 21.31	127
21.30 - 21.27	128
21.26 - 21.23	129
21.22 - 21.19	130
21.18 - 21.15	131
21.14 - 21.11	132
21.10 - 21.07	133
21.06 - 21.03	134
21.02 - 20.99	135
20.98 - 20.95	136
20.94 - 20.91	137
20.90 - 20.87	138
20.86 - 20.83	139
20.82 - 20.79	140
20.78 - 20.75	141
20.74 - 20.71	142
20.70 - 20.67	143
20.66 - 20.63	144
20.62 - 20.60	145



MODIFIED HEXAGONAL OBSTACLE U12 & YOUNGER ALL ATHLETES

Hex Combined Time (sec)	Combine Points
15.15 - 15.12	1
15.11 - 15.08	2
15.07 - 15.04	3
15.03 - 15.00	4
14.99 - 14.96	5
14.95 - 14.92	6
14.91 - 14.88	7
14.87 - 14.84	8
14.83 - 14.80	9
14.79 - 14.76	10
14.75 - 14.72	11
14.71 - 14.68	12
14.67 - 14.64	13
14.63 - 14.60	14
14.59 - 14.56	15
14.55 - 14.52	16
14.51 - 14.48	17
14.47 - 14.44	18
14.42 - 14.40	19
14.39 - 14.36	20
14.35 - 14.32	21
14.31 - 14.28	22
14.27 - 14.24	23
14.23 - 14.20	24
14.19 - 14.16	25
14.15 - 14.12	26
14.11 - 14.08	27
14.07 - 14.04	28
14.03 - 14.00	29
13.99 - 13.96	30
13.95 - 13.92	31
13.91 - 13.88	32
13.87 - 13.84	33
13.83 - 13.80	34
13.79 - 13.76	35
13.75 - 13.72	36
13.71 - 13.68	37
13.67 - 13.64	38
13.63 - 13.60	39
13.59 - 13.56	40
13.55 - 13.52	41
13.51 - 13.48	42
13.47 - 13.44	43
13.43 - 13.42	44
13.39 - 13.36	45
13.35 - 13.32	46
13.31 - 13.28	47
13.27 - 13.24	48
13.23 - 13.20	49
13.19 - 13.16	50

Hex Combined Time (sec)	Combine Points
13.15 - 13.11	51
13.10 - 13.08	52
13.07 - 13.04	53
13.03 - 13.00	54
12.99 - 12.96	55
12.95 - 12.92	56
12.91 - 12.88	57
12.87 - 12.84	58
12.83 - 12.80	59
12.79 - 12.76	60
12.75 - 12.72	61
12.71 - 12.68	62
12.66 - 12.64	63
12.63 - 12.60	64
12.59 - 12.56	65
12.55 - 12.52	66
12.51 - 12.48	67
12.47 - 12.44	68
12.43 - 12.40	69
12.39 - 12.36	70
12.35 - 12.32	71
12.31 - 12.28	72
12.27 - 12.24	73
12.23 - 12.20	74
12.19 - 12.16	75
12.15 - 12.12	76
12.11 - 12.08	77
12.07 - 12.04	78
12.03 - 12.00	79
11.99 - 11.96	80
11.95 - 11.92	81
11.91 - 11.88	82
11.87 - 11.84	83
11.82 - 11.80	84
11.79 - 11.76	85
11.75 - 11.72	86
11.71 - 11.68	87
11.67 - 11.64	88
11.63 - 11.60	89
11.59 - 11.56	90
11.55 - 11.52	91
11.51 - 11.48	92
11.47 - 11.44	93
11.43 - 11.40	94
11.39 - 11.36	95
11.35 - 11.32	96
11.31 - 11.28	97
11.27 - 11.24	98
11.23 - 11.20	99
11.19 - 11.16	100

Hex Combined Time (sec)	Combine Points
11.15 - 11.12	101
11.11 - 11.08	102
11.07 - 11.04	103
11.03 - 11.00	104
10.99 - 10.96	105
10.95 - 10.92	106
10.91 - 10.88	107
10.87 - 10.84	108
10.83 - 10.80	109
10.79 - 10.76	110
10.75 - 10.72	111
10.71 - 10.68	112
10.67 - 10.64	113
10.63 - 10.60	114
10.59 - 10.56	115
10.55 - 10.52	116
10.51 - 10.48	117
10.47 - 10.44	118
10.43 - 10.40	119
10.39 - 10.36	120
10.35 - 10.32	121
10.31 - 10.28	122
10.27 - 10.24	123
10.23 - 10.20	124
10.19 - 10.16	125
10.15 - 10.12	126
10.11 - 10.08	127
10.07 - 10.04	128
10.03 - 10.00	129
9.99 - 9.96	130
9.95 - 9.92	131
9.90 - 9.88	132
9.87 - 9.84	133
9.83 - 9.80	134
9.79 - 9.76	135
9.75 - 9.72	136
9.71 - 9.68	137
9.67 - 9.64	138
9.63 - 9.60	139
9.59 - 9.56	140
9.55 - 9.52	141
9.51 - 9.48	142
9.57 - 9.44	143
9.42 - 9.40	144
9.39 - 9.37	145



STANDING LONG JUMP

Male Standing Long Jump	
Distance (m)	Points
1.30	2
1.34	4
1.38	6
1.42	9
1.46	11
1.50	13
1.54	15
1.58	17
1.62	19
1.66	21
1.70	23
1.74	25
1.78	27
1.82	29
1.86	31
1.90	33
1.94	36
1.98	38
2.02	40
2.06	42
2.10	44
2.14	46
2.18	48
2.22	50
2.26	52
2.30	54
2.34	56
2.38	58
2.42	60
2.46	62
2.50	65
2.54	67
2.58	69
2.62	71
2.66	73
2.70	75
2.74	77
2.78	79
2.82	81
2.86	83
2.90	85
2.94	87
2.98	89
3.02	92
3.06	94
3.10	96
3.14	98
3.18	100
3.22	102
3.26	104
3.30	106
3.34	108
3.38	110
3.42	112
3.46	114
3.50	116
3.54	118
3.60	120
3.66	121
3.70	123
3.75	125

Female Standing Long Jump	
Distance (m)	Points
1.30	2
1.34	4
1.36	6
1.39	9
1.42	11
1.45	13
1.48	15
1.51	17
1.54	19
1.57	21
1.60	23
1.63	25
1.66	27
1.69	29
1.72	31
1.75	33
1.78	36
1.81	38
1.84	40
1.87	42
1.90	44
1.93	46
1.96	48
1.99	50
2.02	52
2.05	54
2.08	56
2.11	58
2.14	60
2.17	62
2.20	65
2.23	67
2.26	69
2.29	71
2.32	73
2.35	75
2.38	77
2.41	79
2.44	81
2.47	83
2.50	85
2.53	87
2.56	89
2.59	92
2.62	94
2.65	96
2.68	98
2.71	100
2.74	102
2.77	104
2.80	106
2.83	108
2.86	110
2.89	112
2.92	114
2.95	116
2.98	118
3.02	120
3.06	121
3.10	123
3.15	125



DOUBLE LEG PENTA JUMP WOMEN

U14 to U21+ Double Leg Penta Jump	
Distance (m)	Points
7.5	2
7.6	4
7.7	6
7.8	9
7.9	11
8.0	13
8.1	15
8.2	17
8.3	19
8.4	21
8.5	23
8.6	25
8.7	27
8.8	29
8.9	31
9.0	33
9.1	36
9.2	38
9.3	40
9.4	42
9.5	44
9.6	46
9.7	48
9.8	50
9.9	52
10.0	54
10.1	56
10.2	58
10.3	60
10.4	62
10.5	65
10.6	67
10.7	69
10.8	71
10.9	73
11.0	75
11.1	77
11.2	79
11.3	81
11.4	83
11.5	85
11.6	87
11.7	89
11.8	92
11.9	94
12.0	96
12.1	98
12.2	100
12.3	102
12.4	104
12.5	106
12.6	108
12.7	110
12.8	112
12.9	114
13.0	116
13.1	118
13.2	120
13.3	121
13.4	123
13.5	125

DOUBLE LEG PENTA JUMP MEN

U16 Men & Older Double Leg Penta Jump	
Distance (m)	Points
9.1	2
9.2	4
9.3	6
9.4	8
9.5	9
9.6	11
9.7	13
9.8	15
9.9	16
10.0	18
10.1	20
10.2	22
10.3	24
10.4	25
10.5	27
10.6	29
10.7	31
10.8	32
10.9	34
11.0	36
11.1	38
11.2	40
11.3	41
11.4	43
11.5	45
11.6	47
11.7	48
11.8	50
11.9	52
12.0	54
12.1	55
12.2	57
12.3	59
12.4	61
12.5	63
12.6	64
12.7	66
12.8	68
12.9	70
13.0	71
13.1	73
13.2	75
13.3	77
13.4	79
13.5	80
13.6	82
13.7	84
13.8	86
13.9	87
14.0	89
14.1	91
14.2	93
14.3	95
14.4	96
14.5	98
14.6	100
14.7	102
14.8	103
14.9	105
15.0	107
15.1	109
15.2	111
15.3	112
15.4	114
15.5	116
15.6	117
15.7	119
15.8	120
15.9	122
16.0	123
16.1	125



SINGLE LEG PENTA JUMP WOMEN

SINGLE LEG PENTA JUMP MEN

U14 to U21+ Single Leg Penta Jump	
Distance (m)	Points
6.2	2
6.3	4
6.4	6
6.5	9
6.6	11
6.7	13
6.8	15
6.9	17
7.0	19
7.1	21
7.2	23
7.3	25
7.4	27
7.5	29
7.6	31
7.7	33
7.8	36
7.9	38
8.0	40
8.1	42
8.2	44
8.3	46
8.4	48
8.5	50
8.6	52
8.7	54
8.8	56
8.9	58
9.0	60
9.1	62
9.2	65
9.3	67
9.4	69
9.5	71
9.6	73
9.7	75
9.8	77
9.9	79
10.0	81
10.1	83
10.2	85
10.3	87
10.4	89
10.5	92
10.6	94
10.7	96
10.8	98
10.9	100
11.0	102
11.1	104
11.2	106
11.3	108
11.4	110
11.5	112
11.6	114
11.7	116
11.8	118
11.9	120
12.0	121
12.1	123
12.2	125

U14 to U21+ Single Leg Penta Jump	
Distance (m)	Points
7.2	1
7.3	2
7.4	4
7.5	6
7.6	7
7.7	8
7.8	11
7.9	12
8.0	14
8.1	16
8.2	18
8.3	19
8.4	20
8.5	23
8.6	24
8.7	26
8.8	28
8.9	29
9.0	31
9.1	33
9.2	34
9.3	36
9.4	38
9.5	39
9.6	41
9.7	43
9.8	44
9.9	46
10.0	48
10.1	49
10.2	51
10.3	53
10.4	54
10.5	56
10.6	58
10.7	59
10.8	61
10.9	63
11.0	64
11.1	66
11.2	60
11.3	71
11.4	74
11.5	75
11.6	76
11.7	77
11.8	80
11.9	81
12.0	83
12.1	84
12.2	85
12.3	86
12.4	88
12.5	90
12.6	91
12.7	93
12.8	95
12.9	96
13.0	98
13.1	102
13.2	105
13.3	106
13.4	109
13.5	113
13.6	115
13.7	118
13.8	122
13.9	125



MAX PUSH UPS (TEMPO IMPOSED)

Push Up Test	
# Reps	Points
0	2
1	4
2	6
3	9
4	11
5	13
6	15
7	17
8	19
9	21
10	23
11	25
12	27
13	29
14	31
15	33
16	36
17	38
18	40
19	42
20	44
21	46
22	48
23	50
24	52
25	54
26	56
27	58
28	60
29	62
30	65
31	67
32	69
33	71
34	73
35	75
36	77
37	79
38	81
39	83
40	85
41	87
42	89
43	92
44	94
45	96
46	98
47	100
48	101
49	102
50	103
51	104
52	105
53	106
54	107
55	108
56	109
57	110
58	111
59	112
60	113
61	114
62	115
63	117
64	118
65	120
66	121
67	122
68	123
69	124
70	125



PULL UPS ALL ATHLETES

Pull Ups	
# Reps	Points
1	1
2	2
3	5
4	6
5	7
6	9
7	11
8	14
9	18
10	22
11	26
12	30
13	36
14	40
15	42
16	48
17	54
18	60
19	66
20	72
21	78
22	84
23	90
24	96
25	105



SIT UPS ALL ATHLETES

Sit Up Test	
# Reps	Points
0	2
1	4
2	6
3	9
4	11
5	13
6	15
7	17
8	19
9	21
10	23
11	25
12	27
13	29
14	31
15	33
16	36
17	38
18	40
19	42
20	44
21	46
22	48
23	50
24	52
25	54
26	56
27	58
28	60
29	62
30	65
31	67
32	69
33	71
34	73
35	75
36	77
37	79
38	81
39	83
40	85
41	87
42	89
43	92
44	94
45	96
46	98
47	100
48	101
49	102
50	103
51	104
52	105
53	106
54	107
55	108
56	109
57	110
58	111
59	112
60	113
61	114
62	115
63	117
64	118
65	120
66	121
67	122
68	123
69	124
70	125



BRUTAL BENCH ALL ATHLETES

Brutal Bench	
# Reps	Points
15	0
16	10
17	20
18	30
19	40
20	50
21	60
22	70
23	80
24	90
25	100
26	110
27	120
28	130
29	140
30	150
31	152
32	154
33	156
34	158
35	160
36	160
37	161
38	161
39	161
40	161



90 SECOND BOX JUMP FEMALE

Women 90 sec Box Jump	
# Jumps	Points
39	0
40	7
41	13
42	20
43	26
44	33
45	38
46	43
47	49
48	54
49	60
50	65
51	71
52	76
53	81
54	87
55	92
56	98
57	103
58	108
59	114
60	119
61	124
62	130
63	136
64	140
65	146
66	152
67	157
68	163
69	168
70	173
71	179
72	184
73	190
74	195
75	200
76	206
77	211
78	217
79	222
80	228
81	233
82	238
83	244
84	249
85	255
86	260
87	266
88	271
89	276
90	282
91	287
92	293
93	298
94	304
95	309
96	314
97	320
98	325



60 SECOND BOX JUMP U14 FEMALE

45 SECOND BOX JUMP U12 & YOUNGER

U14 60 sec Box Jump	
# Jumps	Points
48	0
49	6
50	13
51	19
52	26
53	32
54	39
55	45
56	52
57	58
58	65
59	71
60	77
61	82
62	88
63	93
64	99
65	105
66	112
67	118
68	125
69	131
70	138
71	144
72	151
73	157
74	164
75	169
76	174
77	180
78	185
79	191
80	197
81	204
82	210
83	217
84	223
85	230
86	236
87	243
88	249
89	256
90	261
91	267
92	275
93	280
94	285
95	291
96	297
97	304
98	310
99	317
100	325

U12 & Younger 45 Sec Box Jump	
# Jumps	Points
25	8
26	16
27	24
28	32
29	40
30	48
31	56
32	64
33	72
34	80
35	88
36	96
37	104
38	112
39	120
40	128
41	136
42	144
43	152
44	160
45	168
46	176
47	184
48	192
49	200
50	208
51	216
52	224
53	232
54	240
55	248
56	256
57	264
58	272
59	280
60	288
61	296
62	304
63	312
64	320
65	325



90 SECOND BOX JUMP MALE

U16 & Older 90 sec Box Jump	
# Jumps	Points
61	0
62	7
63	13
64	20
65	26
66	33
67	38
68	43
69	49
70	54
71	60
72	65
73	71
74	76
75	81
76	87
77	92
78	98
79	103
80	108
81	114
82	119
83	124
84	130
85	136
86	140
87	146
88	152
89	157
90	163
91	168
92	173
93	179
94	184
95	190
96	195
97	200
98	206
99	211
100	217
101	222
102	228
103	233
104	238
105	244
106	249
107	255
108	260
109	266
110	271
111	276
112	282
113	287
114	293
115	298
116	304
117	309
118	314
119	320
120	325



60 SECOND BOX JUMP U14 MALE

45 SECOND BOX JUMP U12 & YOUNGER MALE

U14 60 sec Box Jump	
# Jumps	Points
48	0
49	6
50	13
51	19
52	26
53	32
54	39
55	45
56	52
57	58
58	65
59	71
60	77
61	82
62	88
63	93
64	99
65	105
66	112
67	118
68	125
69	131
70	138
71	144
72	151
73	157
74	164
75	169
76	174
77	180
78	185
79	191
80	197
81	204
82	210
83	217
84	223
85	230
86	236
87	243
88	249
89	256
90	261
91	267
92	275
93	280
94	285
95	291
96	297
97	304
98	310
99	317
100	325

U12 & Younger 45 Sec Box Jump	
# Jumps	Points
25	8
26	16
27	24
28	32
29	40
30	48
31	56
32	64
33	72
34	80
35	88
36	96
37	104
38	112
39	120
40	128
41	136
42	144
43	152
44	160
45	168
46	176
47	184
48	192
49	200
50	208
51	216
52	224
53	232
54	240
55	248
56	256
57	264
58	272
59	280
60	288
61	296
62	304
63	312
64	320
65	328



SUBMAXIMAL SQUAT

Submaximal Squat	
Reps	Points
6	0
7	9
8	18
9	28
10	37
11	46
12	55
13	65
14	74
15	83
16	92
17	102
18	111
19	120
20	129
21	138
22	148
23	157
24	166
25	175
26	185
27	194
28	203
29	212
30	222
31	231
32	240
33	243
34	246
35	248
36	251
37	254
38	254
39	255
40	256
41	256
42	257
43	258
44	259
45	260



SUBMAXIMAL DEADLIFT

Submaximal Deadlift	
Reps	Points
6	0
7	9
8	18
9	28
10	37
11	46
12	55
13	65
14	74
15	83
16	92
17	102
18	111
19	120
20	129
21	138
22	148
23	157
24	166
25	175
26	185
27	194
28	203
29	212
30	222
31	231
32	240
33	243
34	246
35	248
36	251
37	254
38	254
39	255
40	256
41	256
42	257
43	258
44	259
45	260



APPENDIX B
SCORE RECORDING SHEETS

AIS 20m SHUTTLE RUN (BEEP TEST) SCORE SHEET

Skill Station Leader: _____ Skill Combine Date: _____

Gender: _____ Age Context: _____

Athlete Bib #	Level, Shuttle <i>Example – 12,5</i>	Athlete Bib #	Level, Shuttle <i>Example – 12,5</i>	Athlete Bib #	Level, Shuttle <i>Example – 12,5</i>

HEXAGONAL OBSTACLE
MODIFIED HEXAGONAL AGILITY SCORE SHEET

Skill Station Leader: _____ Skill Combine Date: _____

Gender: _____ Age Context: _____

Athlete/Bib #	Trial 1 (s) CW	Trial 2 (s) CW	Trial 3 (s) CW	Best Trial (s) (CW)	Trial 1 (s) CCW	Trial 2 (s) CCW	Trial 3 (s) CCW	Best Trial (s) (CCW)

** CW = Clockwise
***CCW = Counterclockwise

STANDING LONG JUMP SCORE SHEET

Skill Station Leader: _____ Skill Combine Date: _____

Gender: _____ Age Context: _____

Athlete Bib Number	Trial 1 Distance (m)	Trial 2 Distance (m)	Trial 3 Distance (m)	Best Trial Distance (m)

DOUBLE LEG PENTA JUMP SCORE SHEET

Skill Station Leader: _____ Skill Combine Date: _____

Gender: _____ Age Context: _____

Athlete Bib Number	Trial 1 Distance (m)	Trial 2 Distance (m)	Trial 3 Distance (m)	Best Trial Distance (m)

SINGLE LEG PENTA JUMP SCORE SHEET

Skill Station Leader: _____ Skill Combine Date: _____

Gender: _____ Age Context: _____

Athlete Bib Number	Left Trial 1 Distance (m)	Left Trial 2 Distance (m)	Left Trial 3 Distance (m)	Left Best Trial Distance (m)	Right Trial 1 Distance (m)	Right Trial 2 Distance (m)	Right Trial 3 Distance (m)	Right Best Trial Distance (m)

MAX PUSH-UPS (TEMPO IMPOSED) SCORE SHEET

Skill Station Leader: _____ **Skill Combine Date:** _____

Gender: _____ **Age Context:** _____

Athlete Bib #	#Push – Up Reps	Athlete Bib #	#Push – Up Reps	Athlete Bib #	#Push – Up Reps

PULL UPS SCORE SHEET

Skill Station Leader: _____ Skill Combine Date: _____

Gender: _____ Age Context: _____

Athlete Bib #	#Push – Up Reps	Athlete Bib #	#Push – Up Reps	Athlete Bib #	#Push – Up Reps

FLEXED ARM HANG SCORE SHEET

Skill Station Leader: _____ Skill Combine Date: _____

Gender: _____ Age Context: _____

Athlete Bib #	Time (s)	Athlete Bib #	Time (s)	Athlete Bib #	Time (s)

SIT UPS SCORE SHEET

Skill Station Leader: _____ Skill Combine Date: _____

Gender: _____ Age Context: _____

Athlete Bib #	#Sit-up Reps	Athlete Bib #	#Sit-up Reps	Athlete Bib #	#Sit-up Reps

BRUTAL BENCH SCORE SHEET

Skill Station Leader: _____ Skill Combine Date: _____

Gender: _____ Age Context: _____

Athlete Bib #	#Brutal Bench Reps	Athlete Bib #	#Brutal Bench Reps	Athlete Bib #	#Brutal Bench Reps

45 SECOND BOX JUMP SCORE SHEET

Skill Station Leader: _____ Skill Combine Date: _____

Gender: _____ Age Context: _____

Athlete Bib Number	#Jumps 15 (s)	#Jumps 30 (s)	#Jumps 45 (s)	Total # Jumps

60 SECOND BOX JUMP SCORE SHEET

Skill Station Leader: _____ **Skill Combine Date:** _____

Gender: _____ **Age Context:** _____

Athlete Bib Number	#Jumps 15 (s)	#Jumps 30 (s)	#Jumps 45 (s)	#Jumps 60 (s)	Total # Jumps



90 SECOND BOX JUMP SCORE SHEET

Skill Station Leader: _____ Skill Combine Date: _____

Gender: _____ Age Context: _____

Athlete Bib Number	#Jumps 30 (s)	#Jumps 45 (s)	#Jumps 60 (s)	#Jumps 75 (s)	#Jumps 90 (s)	Total # Jumps



APPENDIX C

AIS 20 m SHUTTLE RUN (BEEP TEST) LAYOUT

(25 - 30 m total distance | 25 - 30 m de distance totale)

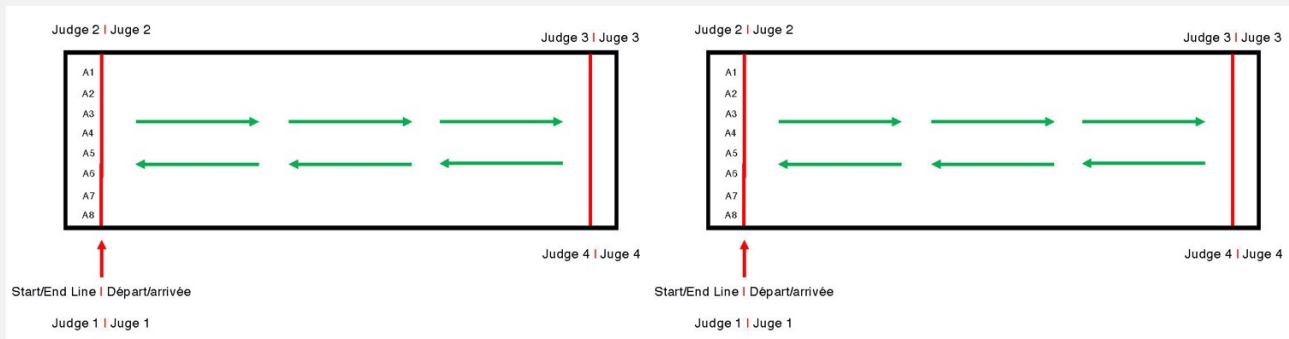
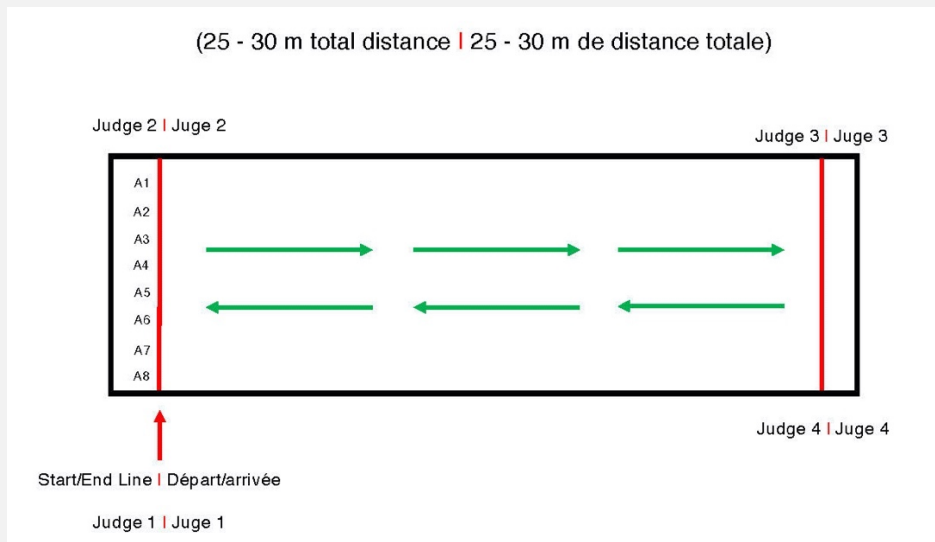

(50 – 60m total distance | 50 – 60 m de distance totale)



APPENDIX D

GYM TESTING – TECHNIQUE EVALUATION FORM

SQUAT TECHNICAL EVALUATION

Athlete Name/Bib #	Date Evaluated	
Combine Location	Evaluator Name	
Technical Evaluation points	YES	NO
Does the athlete have any known or acknowledge any contraindications to performing a squat?		
Athlete demonstrates the correct squat starting position.		
Athlete correctly moves the bar off the supports with a proper stance prior to executing the downward movement.		
Does the athlete display poor posture at the starting position of the movement?		
Athlete completes the squat downward movement phase correctly.		
Do the athletes' knees travel excessively forward over the toes?		
Does the athlete bend at the waist?		
Do the athletes' heels lift off the floor?		
Athlete completes the upward movement phase correctly.		
Does the athlete round their back at any stage of the lift?		
Does the athlete hyper-extend their lower back at any stage of the lift?		
Does the athlete replace the bar on the supports in a controlled manner?		
The athlete has passed the deadlift technical evaluation		
Comments:		
Submaximal Squat Evaluation (U18+)		
Does the athlete have any known or acknowledge any contraindications that prevent them from properly executing a submaximal squat?		
Has the athlete provided their 4-week training history?		
Using their provided training history, what is their predicted 1RM squat (kg)?		
Athlete weight in kilograms		
Load Calculation used for evaluation – circle the load calculation utilized	75% predicted 1 RM (kg)	Calculated squat load (kg) based on athlete weight
Calculated load for evaluation (kg)		
Number of submaximal squat reps completed		
Comments:		



GYM TESTING – SUBMAXIMAL DEADLIFT & TECHNIQUE EVALUATION FORM

Athlete Name	Date Evaluated	
Combine Location	Evaluator Name	
Technical Evaluation points	YES	NO
Does the athlete have any known or acknowledge any contraindications to performing a deadlift?		
Athlete demonstrates the correct deadlift starting position.		
Athlete correctly executes the proper upward movement phase of the deadlift.		
Does the athlete display poor posture at the starting position of the movement?		
Does the bar travel too far in front of the feet?		
Does the athlete maintain their shoulders over the bar?		
Does the athlete bend their arms to pull the weight up?		
Do the hips rise (extend) faster than the knees?		
Is the bar too far in front of the body after the bar has cleared the knees?		
Does the athlete round their back at any stage of the lift?		
Does the athlete hyper-extend their lower back at the top of the lift?		
Does the head and chest of the athlete drop forward during the descent phase of the lift?		
Athlete completes the correct downward movement phase of the deadlift.		
The athlete has passed the deadlift technical evaluation		
Comments:		
Submaximal Deadlift Evaluation (U18+)		
Does the athlete have any known or acknowledge any contraindications that prevent them from properly executing a submaximal deadlift?		
Has the athlete provided their 4-week training history?		
Using their provided training history, what is their predicted 1RM squat (kg)?		
Athlete weight in kilograms		
Load Calculation used for evaluation – circle the load calculation utilized	75% predicted 1 RM (kg)	Calculated squat load (kg) based on athlete weight
Calculated load for evaluation (kg)		
Number of submaximal deadlift reps completed		

Comments:



APPENDIX E

ACA FITNESS COMBINE INDIVIDUAL SCORE FORM

U10 ATHLETES

Athlete Name		Combine Location	
Date	Age	Sex	
		Raw Score	Points Earned
AIS 20m Shuttle Run	Level, Shuttle		
Hexagon (s)	Trial 1 CW		
	Trial 2 CW		
	Trial 3 CW		
	Best Trial CW		
	Trial 1 CCW		
	Trial 2 CCW		
	Trial 3 CCW		
	Best Trial CCW		
	Total Time		
Standing Long Jump (m)	Trial 1		
	Trial 2		
	Trial 3		
	Best Trial		
Max Push Ups (Tempo Imposed)	Reps		
Pull Ups	Reps		
Flexed Arm Hang (s)	Seconds		N/A
Sit Ups	Reps		
Box Jump	15 s		
	30 s		
	45 s		
	Total Jumps		
Squat Technique Check		Clear	Not Clear
Deadlift Technique Check		Clear	Not Clear
		Total Points Earned	



U12 ATHLETES

Athlete Name		Combine Location	
Date	Age	Sex	
		Raw Score	Points Earned
AIS 20m Shuttle Run	Level, Shuttle		
Hexagon (s)	Trial 1 CW		
	Trial 2 CW		
	Trial 3 CW		
	Best Trial CW		
	Trial 1 CCW		
	Trial 2 CCW		
	Trial 3 CCW		
	Best Trial CCW		
	Total Time		
Standing Long Jump (m)	Trial 1		
	Trial 2		
	Trial 3		
	Best Trial		
Max Push Ups (Tempo Imposed)	Reps		
Pull Ups	Reps		
Flexed Arm Hang (s)	Seconds		N/A
Sit Ups	Reps		
Box Jump	15 s		
	30 s		
	45 s		
	60 s		
	Total Jumps		
Squat Technique Check		Clear	Not Clear
Deadlift Technique Check		Clear	Not Clear
		Total Points Earned	

Comments:



U14 ATHLETES

Athlete Name		Combine Location	
Date	Age	Sex	
		Raw Score	Points Earned
AIS 20m Shuttle Run	Level, Shuttle		
Hexagon (s)	Trial 1 CW		
	Trial 2 CW		
	Trial 3 CW		
	Best Trial CW		
	Trial 1 CCW		
	Trial 2 CCW		
	Trial 3 CCW		
	Best Trial CCW		
	Total Time		
Standing Long Jump (m)	Trial 1		
	Trial 2		
	Trial 3		
	Best Trial		
Double Leg Penta Jump (m)	Trial 1		
	Trial 2		
	Trial 3		
	Best Trial		
Max Push Ups (Tempo Imposed)	Reps		
Pull Ups	Reps		
Flexed Arm Hang (s)	Seconds		N/A
Sit Ups	Reps		
Box Jump	15 s		
	30 s		
	45 s		
	60 s		
	Total Jumps		
Squat Technique Check		Clear	Not Clear
Deadlift Technique Check		Clear	Not Clear
		Total Points Earned	

Comments:



U16 ATHLETES

Athlete Name		Combine Location		
Date		Age		Sex
		Raw Score	Points Earned	
AIS 20m Shuttle Run	Level, Shuttle			Comments:
Hexagon (s)	Trial 1 CW			
	Trial 2 CW			
	Trial 3 CW			
	Best Trial CW			
	Trial 1 CCW			
	Trial 2 CCW			
	Trial 3 CCW			
	Best Trial CCW			
	Total Time			
	Standing Long Jump (m)	Trial 1		
Trial 2				
Trial 3				
Best Trial				
Double Leg Penta Jump (m)	Trial 1			
	Trial 2			
	Trial 3			
	Best Trial			
Single Leg Penta (m)	Trial 1 - L			
	Trial 2 - L			
	Trial 3 - L			
	Best Trial - L			
	Trial 1 - R			
	Trial 2 - R			
	Trial 3 - R			
	Best Trial - R			
	Diff L/R			
	Avg. L + R Best			
Max Push Ups (Tempo Imposed)	Reps			
Pull Ups	Reps			
Brutal Bench	Reps			
Box Jump	30 s			
	45 s			
	60 s			
	75 s			
	90 s			
	Total Jumps			
Squat Technique Check		Clear	Not Clear	
Deadlift Technique Check		Clear	Not Clear	
		Total Points Earned		



U18+ ATHLETES

Athlete Name		Combine Location	
Date	Age	Sex	
		Raw Score	Points Earned
AIS 20m Shuttle Run	Level, Shuttle		
Hexagon (s)	Trial 1 CW		
	Trial 2 CW		
	Trial 3 CW		
	Best Trial CW		
	Trial 1 CCW		
	Trial 2 CCW		
	Trial 3 CCW		
	Best Trial CCW		
	Total Time		
	Standing Long Jump (m)	Trial 1	
Trial 2			
Trial 3			
Best Trial			
Double Leg Penta Jump (m)	Trial 1		
	Trial 2		
	Trial 3		
	Best Trial		
Single Leg Penta (m)	Trial 1 - L		
	Trial 2 - L		
	Trial 3 - L		
	Best Trial - L		
	Trial 1 - R		
	Trial 2 - R		
	Trial 3 - R		
	Best Trial - R		
	Diff L/R		
	Avg. L + R Best		
Max Push Ups (Tempo Imposed)	Reps		
Pull Ups	Reps		
Brutal Bench	Reps		
Box Jump	30 s		
	45 s		
	60 s		
	75 s		
	90 s		
	Total Jumps		
Squat Technique Check		Clear	Not Clear
Submaximal Squat	Calculated Weight		
	Reps		
Deadlift Technique Check		Clear	Not Clear
Submaximal Deadlift	Calculated Weight		
	Reps		
		Total Points Earned	

Comments:

